







i12 PARTS LIST

No.	Part No.	Description	Rec' Stock	Photo
1	11-1274-2	FLOAT VALVE ¼" CONNECTIONS	2	
2	CH900BPC	BOOSTER PUMP	1	
3	21-0401-6	SIDE PANEL (L)	0	
4	CH900BIS	ICE STORAGE BASKET	0	
5	CH900SW2-ICE	ICE DISCHARGE BLADE FIN	0	
6	CH900SWB	ICE DISCHARGE BLADE FIN BRACKET	0	
7	CH900IFS-T	ICE FULL SENSOR - TRANSMITTER	1	
8	CH900IFS-R	ICE FULL SENSOR - RECEIVER	1	

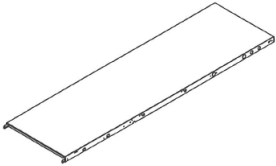
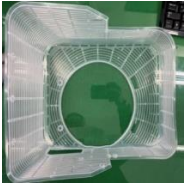
9	41-2164-0	STERILIZER UV LED	2	
10	CH900TWMC	ICE TRAY MOTOR COUPLING	2	
11	CH900EPS-CP	CIRCULATION PUMP ASSY	0	
12	CH900WLDC	COLD WATER LEVEL SENSOR	1	
13	CH900CS	COLD WATER TEMPERATURE SENSOR (COOLING SENSOR)	1	
14	CH900WS-SOL-ASY	WATER SUPPLY SOL VALVE ASSY	0	
15	CH900DWSV-VOD	WATER DISPENSE SOLENOID V/V	1	
16	CH900MTWM	ICE TRAY MOTOR (SPECIAL ORDER)	0	
17	CH900IDD-ASY	ICE DISCHARGE DOOR ASSEMBLY (SPECIAL ORDER)	0	

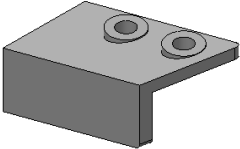
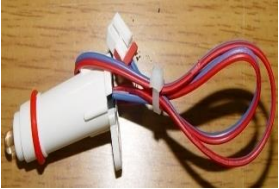
18	91-3423-0	ICE DISPENSE BLADE MOTOR (SPECIAL ORDER)	0	
19	11-0613-5	COLD MANIFOLD	0	
20	CH900HT-ASSY	HOT TANK ASSY	0	
21	51-0347-1	6-IN AIR FILTER (SEDIMENT)	24mo	
22	41-2335-1	MAIN PCB (V.1.0)	0	
23	CH900CWLS	CAPACITIVE WATER LEVEL SENSOR	0	
24	21-1045	SURROUNDING TEMP SENSOR	1	
25	CH900AVF	AUTO FLUSHING VALVE	1	
26	CH900SOLV-RAW	RAW WATER SOLENOID V/V	1	

27	ICESED	SEDIMENT FILTER	PM	
28	ICEPREC	PRE CARBON FILTER	PM	
29	ICEPOSTCA	POST CARBON PLUS FILTER	PM	
30	ICERO	RO MEMBRANE FILTER	PM	
31	22-1855	DRAIN SOLENOID VALVE	1	
32	11-3469-1	FRONT MID COVER ASSY	0	
33	11-3465-1	FRONT UPPER COVER	0	
34	91-4480-0	FRONT DECO ASSY (WELLSYS)	0	
35	11-3475-0	WINDOW DISPLAY	0	

36	41-2145-0	IR SENSOR	0	
37	11-3462-1	REAR COVER	0	
38	11-0755-0	TOP COVER	0	
39	91-4481-0	FRONT LOWER COVER ASSY	0	
40	91-4482-0	DRIP TRAY ASSY	0	

i12 WATER FLOW DIAGRAM

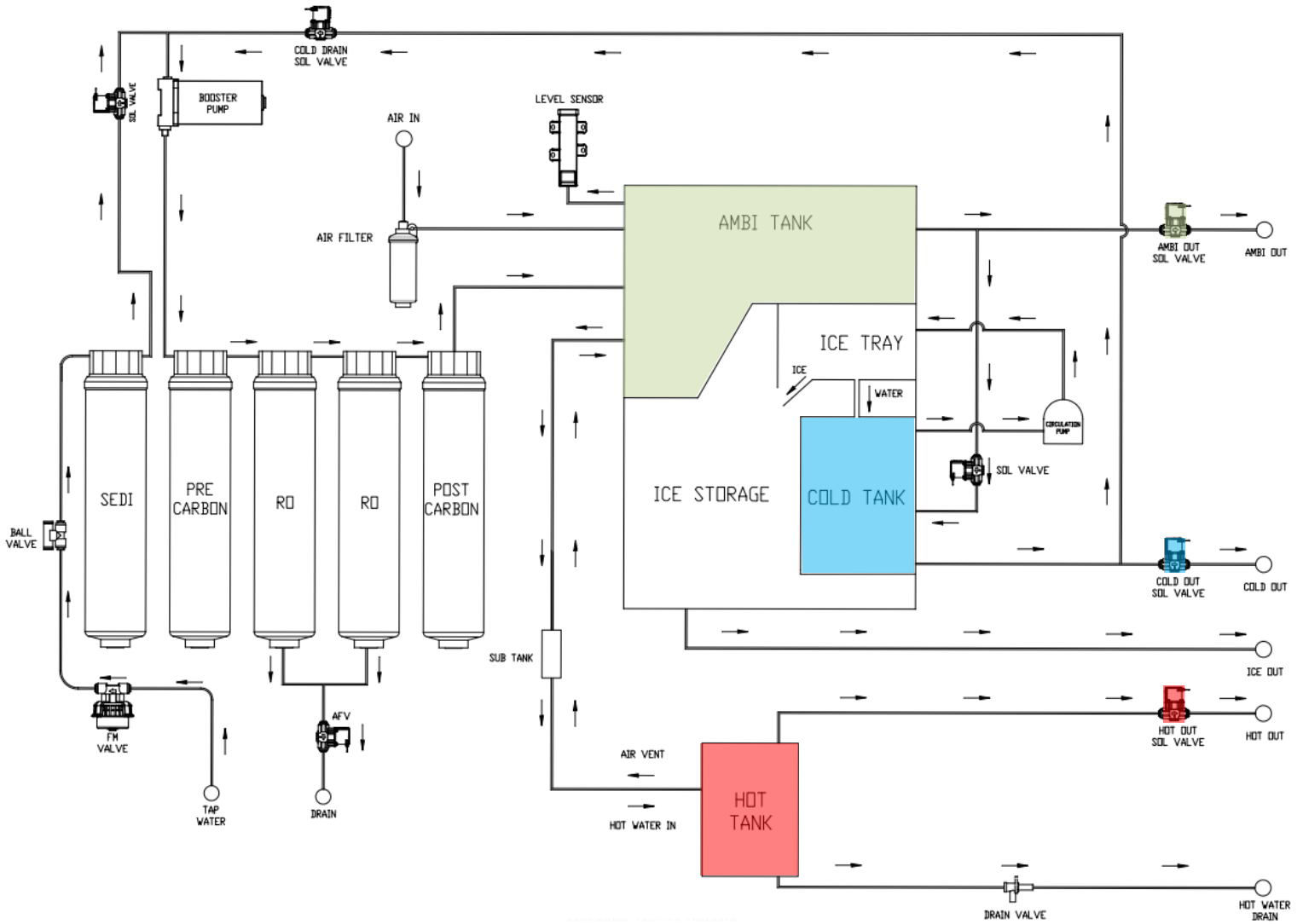

i12 ELECTRICAL DIAGRAM

⚠ DANGER! HIGH VOLTAGE ELECTRICAL HAZARD. PCB (Printed Circuit Board) contains High Voltage. Only trained and qualified technicians should attempt live testing.

