

XL1 MANUAL



Quench USA Inc.
630 Allendale Road, Ste 200
King of Prussia, PA 19406
(855) 558-9796 www.Quenchwater.com

XL1 MANUAL

Congratulations on your choice of the **Wellsys XL1 Water Dispenser**. The **XL1** model dispenses hot, cold, and ambient water. The **Wellsys XL1 Water Dispenser** provides exceptional quality and great tasting water with every use.

INTRODUCTION

Carefully read and follow all instructions to ensure proper and efficient operation of your **Wellsys XL1 Water Dispenser**. Contact your **Authorized Wellsys Dealer** if you have any questions.

Wellsys and **Authorized Wellsys Dealers** employ trained service personnel who are experienced in the installation, function, and repair of this equipment. This publication is written for use by these qualified individuals. **Wellsys** encourages users to learn about products, however, we believe that product knowledge and service is best obtained by consulting your **Authorized Wellsys Dealer**.

Wellsys Water Dispensers should be combined with selected water treatment components to create a system specifically tailored for each application by trained and qualified personnel.

Products manufactured and marketed by **Wellsys** and its affiliates are protected by patents issued or pending in the United States and other countries.

Wellsys reserves the right to change the specifications referred to in this literature at any time, without prior notice. Changes or modifications not expressly approved by **Wellsys** could void the warranty and user's authority to operate the equipment.

TABLE OF CONTENTS

USER GUIDE

- Safety Alert Symbols 4
- Safety Precautions 4
- Features and Benefits 6
- Certifications 7
- Model Designations, Consumables, & General Specs 8
- Shipping Specifications 9
- Receiving Your Equipment 10
- Operating Instructions 11
- Warranty 12

SERVICE GUIDE

- Service Requirements 13
- Parts List..... 14
- Flow Diagram 16
- Construction..... 17

INSTALLATION GUIDE

- Pre-Installation Procedures 18
- Notes on Installation..... 19
- Unpacking the Unit 20
- Filter Flushing Procedure 21
- Sanitizing 24
- Installation 26
- Commissioning..... 28
- Final Inspection 29
- Resetting Hot Tank Overload Thermostat 30

MAINTENANCE

- Preventative Maintenance 31
- System Inspection 32
- Warranty Procedure 32

TROUBLESHOOTING

- Advanced Settings..... 33
- Troubleshooting Guide 35

SAFETY ALERT SYMBOLS

Read and follow all safety information carefully. The signal words used in this manual are selected as shown below and based on an assessment of the degree of potential injury or damage (severe or minor) and the occurrence of injury (occurs or has the potential to occur) when the warning is ignored:

⚠ DANGER!

Indicates a situation which, when not avoided, results in death or severe injury.

⚠ WARNING!

Indicates a situation which, when not avoided, has the potential to result in death or severe injury; and/or severe property damage.

⚠ CAUTION!

Indicates a situation which, when not avoided, results in or has the potential to result in minor injury; and/or minor property damage.

SAFETY PRECAUTIONS

Basic safety precautions should be followed, including the following:

Ensure all Local, State, and Federal Laws and Codes including health and safety guidelines are met when installing **Wellsys** Equipment. Only qualified service technicians should attempt installation and service of **Wellsys** Equipment. Always read the entire operating instructions before using the appliance and save these instructions for future use.

⚠ DANGER! *This product can cause death or severe injury if incorrectly operated, installed or maintained. The installation, maintenance, sanitizing and any repair must be performed by qualified persons trained by Wellsys International or their approved distributors only. Do not remove any panel or cover to protect against electrical shock and exposure to UV radiation.*

⚠ DANGER! **ELECTRICAL SHOCK HAZARD. *Always use a dedicated and properly grounded outlet. Unit should be protected by ground-fault circuit interrupter (GFCI) or residual current device (RCD) having a rated residual operating current not exceeding 30mA. Use only **Wellsys** supplied power cord. Never use extension cords or power strips to connect unit. Do not use if the power supply cord is damaged. Always unplug from power supply prior to servicing.***

⚠ WARNING! **AUTHORIZED USE ONLY. *This appliance is to be used for its intended purpose as described in this manual. Untrained individuals who use this manual assume the risk of any resulting property damage or personal injury. This appliance can't be used by children and persons with reduced physical, sensory, or mental capabilities or lack of experience.***

⚠ WARNING! **DO NOT OPERATE IF DAMAGED. *Unplug and isolate water supply if abnormal conditions exist. Contact Wellsys or authorized dealer for repair, service, and installation to avoid hazards.***

⚠ WARNING! **HOT WATER. *Unit produces Hot Water in excess of 80°C (175°F). Water above 52°C (125°F) can cause severe burns or scalding. Keep unauthorized people and children away from the unit to avoid accidental dispensing of hot water.***

⚠ WARNING! **CONNECT TO POTABLE WATER SUPPLY. *This system is to be used for water only and is NOT intended for use where water is microbiologically unsafe or with water of unknown quality without adequate disinfection before or after the system.***

⚠ WARNING! **TIP HAZARD. *Dispenser could tip or fall causing serious injury if installed with a base. Always install unit on a firm, flat, and level surface and secure unit to cabinet, wall, or***

floor if needed and secure to the base, if applicable. Never place heavy items on top of unit and never climb, stand, or hang on unit or storage cabinet to prevent injury and damage.

⚠ WARNING! UNIT IS HEAVY. TWO PERSON LIFT REQUIRED. Transport unit empty and always use material handling equipment or two people with proper lifting technique to reduce injury risk.

⚠ WARNING! STORE AND TRANSPORT UNIT EMPTY. ALWAYS SANITIZE BEFORE USE.

The unit must be completely drained before storing to avoid stagnation and reduce microbiological contamination (potential bacterial growth). Always sanitize before use to eliminate any potential microbiological contaminants.

⚠ CAUTION! INDOOR USE ONLY. Intended for Household Use. Never expose to direct sunlight, heat sources, or ambient air temperature above 37°C (100°F) or below 2°C (35°F). Install indoors and keep unit away from excessive humidity or rain. Never expose to freezing temperatures. Ensure there is adequate clearance around the unit to allow refrigeration system condenser to dissipate heat. Warmer environments require more clearance around the unit. Minimum clearance around all surfaces of the machine is 2-inches. Installs where the ambient temperature exceeds 27°C (80°F), require a minimum of 4-inches clearance for proper heat dissipation and efficient operation.

⚠ CAUTION! USE A WATER PRESSURE REGULATOR. Wellsys will not be responsible for injury or damage caused by excessive water pressure. Input or feed pressure must be 40 psi to 80 psi. Be aware of any potential pressure surges caused by building/municipal pumping stations. Failure to comply will void all warranties. The manufacturer accepts no liability for damage caused by excessive water pressure.

⚠ CAUTION! USE UV STABILIZED SUPPLY LINES. Feed the unit with a potable ambient or cold-water supply only. Feed water over 37°C (100°F) can damage the treatment components. Water block devices and external leak detectors are strongly recommended. Locate the unit as close to the water supply and the electrical connections as possible. Immediately isolate or close water supply valve and contact service representative if leak is noticed.

⚠ WARNING! SECURE CO2 SUPPLY BOTTLE. When connecting a CO2 tank to the system, please ensure that the CO2 tank is securely fastened to avoid falling. Failure to secure tank can result in property damage and/or bodily harm.

⚠ WARNING! REFRIGERANT SYSTEM. This system is manufactured with 134A refrigerant. Repairs to the refrigeration system must be performed by a certified refrigeration technician only.

⚠ CAUTION! DO NOT PLACE HEAVY ITEM OR WATER CONTAINER ON TOP OF UNIT. Water may leak into the electrical system causing a fire hazard. Heavy items may fall off causing injury.

Contact Wellsys for assistance or help finding an Authorized Service Representative.

XL1 FEATURES AND BENEFITS

Hot, Cold, Ambient Water

The **XL1 Water Dispenser** comes standard with Hot, Cold, and Ambient Water Selections to meet a wide range of customer demands.

Water Capacity and Production

The **XL1 Water Dispenser** holds 1.1 gallons (4.2L) of Hot Water, 5 gallons (18.9L) of Cold Water, 2.5 gallons (9.5L) of Ambient Water.

Large Dispense Area

14.7-inch dispense height with recessed faucet to protect from cross-contamination.

Leak Prevention

XL1 Water Dispensers are supplied with a leak stop device to cut off the water supply in the case of a water leak or overflow.

Touch-Capacitive Dispensing

A Touch Capacitive Screen is used to activate select and dispensing functions as well as operate the technician menus.

Temperature Indication Light

Lights and symbols change color to indicate water temperature being dispensed (Blue for Cold, Red for Hot, Green for Ambient).

RO Water Filtration

The **Wellsys XL1** uses an advanced RO filtration configuration for great tasting water, and implements dual RO membranes, to increase production rate for fast recovery.

Internal LED UV

The **Wellsys XL1** is outfitted with internal LED UV lights to prevent biofilm growth inside the tanks.

Adjustable Temperature Settings

The **Wellsys XL1** water temperatures can be controlled and set to a range of desired temperatures.

ADA Controls

The **Wellsys XL1** has dual temperature select and dispense controls. To the right of the dispense alcove are the ADA Compliant controls that can be used alternatively to the screen.

Ease of Movement

The **Wellsys XL1** is equipped with 4 high-quality and fully mobile casters with position locks to make moving the unit and setting it in place easier.

Internal Condensate Pump Capability

The **Wellsys XL1** has the internal space and power connections to allow the installation of an internal condensate pump, if desired.

CERTIFICATIONS

XL1 Water Dispensers have been tested and certified to rigorous NSF and UL Standards. We believe that performance testing and certifications validate **Wellsys** as a world-leader in Water Dispensers.

Wellsys XL1 Component Certifications Include:



Intertek

UL399 – Certified Drinking Water Cooler

Intertek Labs (ETL) Certified the **XL1 Water Dispenser** to ANSI/UL 399 Standard for Drinking Water Coolers.

CSA C22.2 No. 120-13 CSA Standard for Refrigeration Equipment

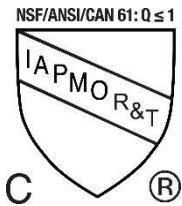

The **Wellsys XL1** system is certified by IAPMO R&T against NSF/ANSI/CAN 61: Q ≤ 1, NSF-372 and CSA B483.1 for material safety, structural integrity, and lead free requirements.

MODEL/PART DESIGNATIONS

BRAND NAME	DESCRIPTION	MODEL - PART NUMBER
XL1	XL1 – Hot, Cold, Ambient	XL1
	WSXL1FR00E(XXXXXX)	

CONSUMABLES

FILTER	REPLACEMENT FREQUENCY	PART NUMBER
SEDIMENT FILTER	24 MONTHS (20,000 gal)	H17-SD3
PRE-CARBON FILTER	24 MONTHS (20,000 gal)	H17-ECS3
RO MEMBRANE (x2)	36 MONTHS	XL12-WRO1280
POST-CARBON FILTER	24 MONTHS (5,000 gal)	XL12-MINERAL
AIR FILTER	36 MONTHS	AF

SPECIFICATIONS

ITEM	XL1
Water Connection	1/4" Quick Connect for both Source and Reject water
Recommended Service Water Pressure	50-70psi (0.5-7kgf/cm ²)
Rate Voltage	AC 120V/60Hz @ 6.0Amps
Power Consumption	1.2A (120W) Cold Water; 500W Hot Tank ; 6.0A (720W) Max
Power Cord	1.9m (6.3ft)
IP Class	IPX1
Climate Class	N Class (32°C +/- 1°C) (89.6°F +/- 33.8°F)
Safety Device	Overheating protector. Water Level Detector. Leak Stop Device. Fuse.
Hot Tank Capacity	1.1gal (4.2L)
Ambient Tank Capacity	2.5gal (9.5L)
Cold Tank Capacity	5gal (18.9L)
Environmental Temperature	Max: 90°F (32°C) Min: 35°F (2°C)
Source Water Temperature	Max: 90°F (32.2°C) Min: 40°F(4.5°C)
Relative Humidity	55% at 78°F(25.5°C)
Refrigerant Gas	R134a; 68g(2.39oz)
R134a Pressures	280Psig (19.3bar) High Side, 88Psig (6.1bar) Low Side

SHIPPING SPECIFICATIONS

ITEM	XL1
Width/Depth/Height	480mm W x 518mm D x 1740mm H 18.9"W x 20.4"D x 68.5"H
Weight (dry)	155lbs (70.3 kg)

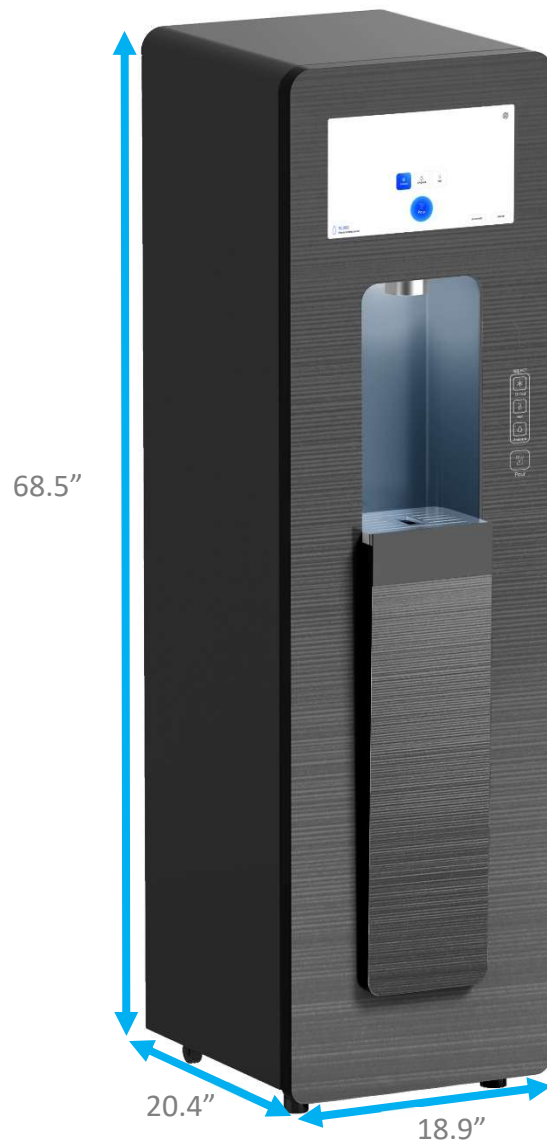

RECEIVING YOUR EQUIPMENT

Upon receipt of your equipment, you should check the following:

1. Are the systems still on the pallet?
2. Confirm the number of boxes you are signing for.
3. Is there any obvious damage to the product or the boxes?

If there are any discrepancies or any obvious damage to the equipment or boxes, please note it on the “Bill of Lading” and/or refuse the shipment.

After receiving the equipment from the carrier, remove packaging and inspect for any hidden freight damage. If freight damage has occurred, call the freight company and customer service (877) 386-0823 to report the damage. Photograph all damages to be submitted with the claim. **THIS MUST BE DONE WITHIN FIVE BUSINESS DAYS OF DELIVERY.** If not reported within 3 business days, Wellsys and/or carrier will not be responsible for replacement or repair.

OPERATING INSTRUCTIONS

The below pictures show the front user interface (UI) and ADA control panel for the *XL1 Water Dispenser*.

To Select Temperature:

On the main screen, touch one of the three temperature selections to designate the temperature of water dispensed. Cold, Ambient, and Hot are the selections, from left to right.

*Unit will default to the cold-water selection.

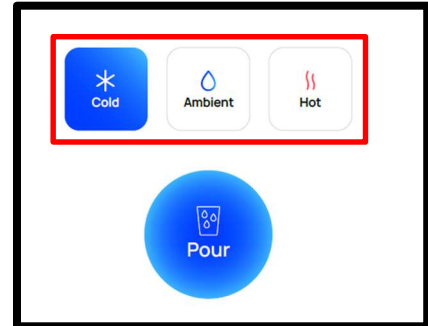

To Dispense Water:

On the main screen, and with the desired temperature selected, touch and hold the large blue Pour button to begin pouring. Release to cease dispensing.

*If the Pour button is not pressed within three seconds of selecting water other than Cold, unit will default back to the cold-water selection.



Using the ADA Controls:

Alternatively, the ADA controls to the right of the drip tray can also be used to select and dispense water. Use the top three buttons to select the desired temperature, and the Pour button to dispense water.



WELLSYS MANUFACTURED WATER DISPENSER LIMITED WARRANTY

The Wellsys XL1 is covered by the Wellsys Warranty for a period of 3 years from the date of purchase against manufacturer defects given the filtration is changed with branded filters on the recommended schedule.

General Provision and Exclusions:

This warranty only applies in the fifty (50) United States and Canada. This warranty does not apply, and no agreement, either written or implied, shall be applicable if the affixed serial number is removed, defaced or obliterated. This warranty does not apply to the filters or Ultra Violet system after exposure to water. Refer to service manual for filter requirements and expected performance. This warranty does not apply if parts used as original or replacement equipment, including filters, are not obtained or authorized through WELLSYS, and such unauthorized usage shall void this warranty. This warranty does not apply to any wetted parts that become inoperative due to lime, scale or other water quality conditions. This warranty does not apply to any machine or components that become inoperable due to a failure by Dealer/Distributor or the end-user to satisfy standards or regulations adopted by any governmental agency. This warranty does not cover performance, failure or damages of any part resulting from external causes such as alterations, abuse, misuse, misapplication, neglect, accident, installation, operation contrary to printed material, corrosion or acts of God.

This warranty only applies to the operative components of the machine and does not apply to the exterior shell or frame to which the shell is attached and the appearance of the machine.

This warranty and any applicable industry certifications for this machine are automatically voided if the machine is altered, modified, or combined with any other machine, equipment or device. Alteration or modification of the machine may cause serious flooding and/or hazardous electrical shock or fire. Except as set forth herein, WELLSYS makes no other warranty, guarantee or agreement expressed, implied or statutory, including any implied of merchantability or fitness for a particular purpose.

The foregoing is in lieu of all other agreements expired or statutory and all other obligations or liabilities of WELLSYS. WELLSYS does not assume or authorize any person to assume any obligations of liability in connection with this product. In no event will WELLSYS be liable for special, incidental, consequential or punitive damages, or for any delay in performance of this warranty agreement due to causes beyond its control.

Export Warranty:

The WELLSYS export warranty shall apply to all area outside of the Continental limits of the United States and Canada. The export warranty shall mirror the domestic warranty set forth above in all respects except that a) the export warranty shall be limited to the Initial Term and there is no coverage for the additional warranty through the first year and b) the Dealer/Distributor shall be responsible for any and all transportation charges to implement the repairs.

ALL WARRANTY REPAIRS SUBJECT TO PRIOR APPROVAL BY THE WELLSYS SERVICE DEPARTMENT IN ORDER TO VALIDATE THAT THE DEFECTIVE COMPONENT IS STILL UNDER WARRANTY.

SERVICE REQUIREMENTS

⚠ WARNING! *Read and understand the contents of this manual before attempting to service the XL1 Water Dispenser. Failure to follow the instructions in this manual could result in death, serious personal injury, or severe property damage. Only trained and qualified technicians should attempt to install, maintain, or service Wellsys Equipment.*

1. Visually inspect all electrical and water connections for signs of wear or damage.

⚠ DANGER! *HIGH VOLTAGE ELECTRICAL HAZARD. Unplug before inspection and service.*

⚠ WARNING! *ULTRAVIOLET RADIATION. Protect your skin and eyes against ultraviolet rays. Never look directly at an operating UV light. Disconnect before removing UV Lamp.*

⚠ CAUTION! *UV LIGHTS ARE HAZARDOUS. Lamps are considered Hazardous Waste and must be disposed of accordingly. Refer to Product MSDS sheet for details.*

2. Ensure there is adequate (minimum of 5") clearance around the **XL1 Water Dispenser** and clean the condenser grill to provide efficient cooling system operation.
3. Sanitize the unit per instructions in the sanitization procedures.

⚠ WARNING! *SANITIZER MAY CONTAIN HAZARDOUS CHEMICALS. Use of proper personal protective equipment such as rubber gloves and eye protection are required.*

4. Clean and sanitize external surfaces of the **XL1 Water Dispenser**. Use soap and water or chemicals that are compatible with ABS plastic and will not damage or degrade the product surfaces.
5. Remove and clean the Faucet. Replace as needed.
6. Flush in filters per instructions, and change filters on predetermined schedule, commonly every 24 months for standard filters.

XL1 PARTS LIST

Note: Only stocked parts are listed.

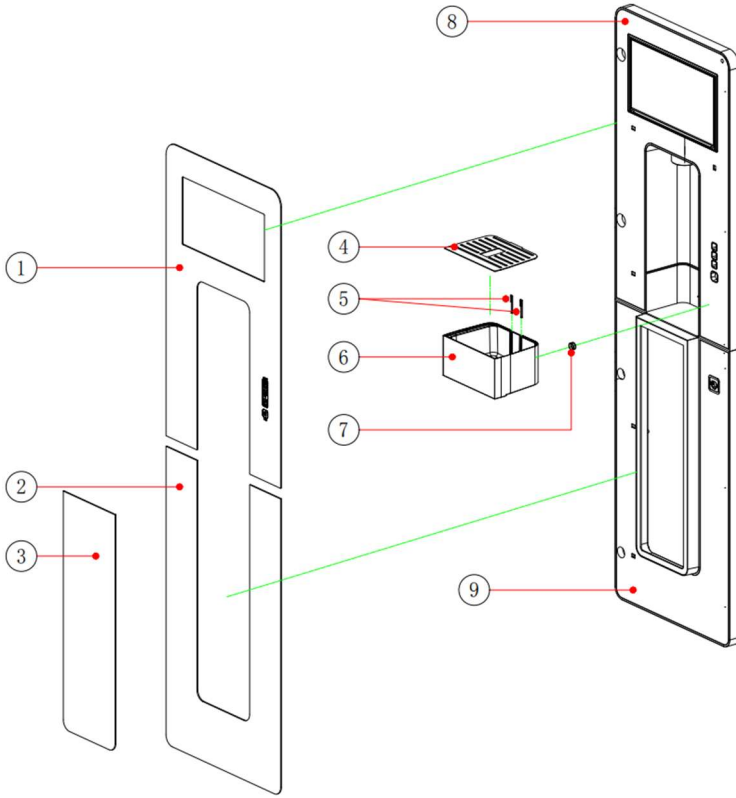

No.	Description	Part #
4+6	Drip Tray Assy (Grill + Tray)	AB156A01
9	Lower Front Panel Assy	AB155A01

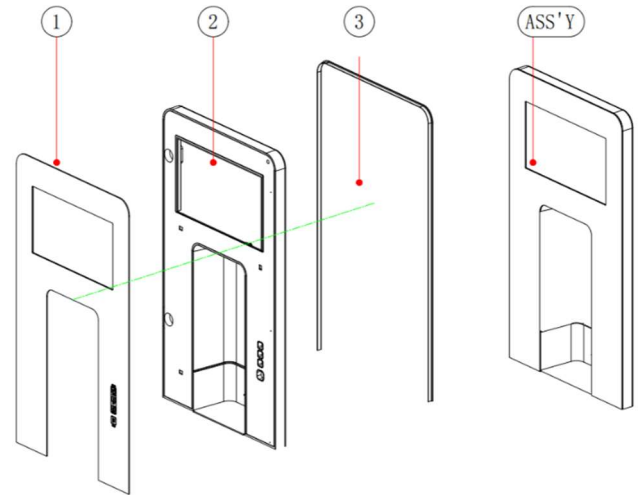

No.	Description	Part #
ASSY	Upper Front Panel Assy	AB154A01

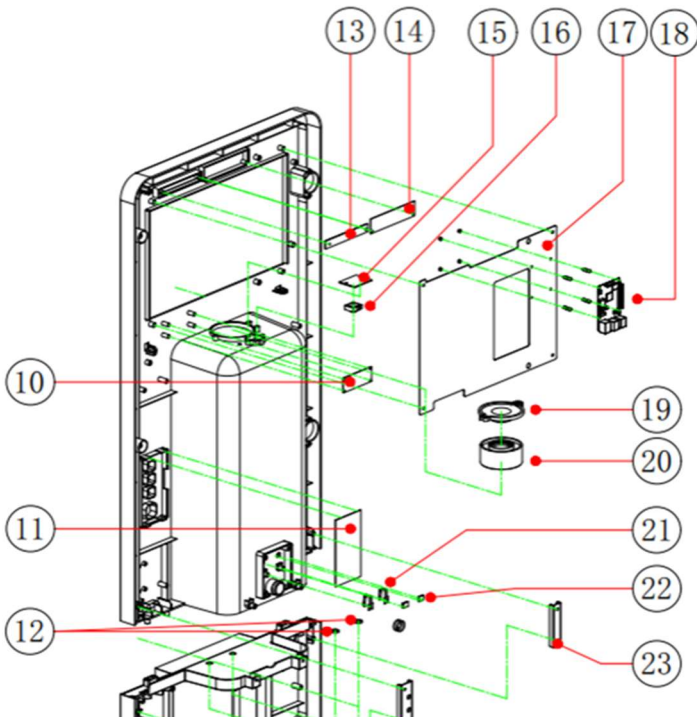

No.	Description	Part #
10	LCD Touch PCB	EB164A01
11	Touch PCB	EB162A01
14	LVDS Converter PCB	EB166A01
15	Dispense LED PCB	EB157A01
18	Raspberry Pi PCB	EB159A01
20	Dispense Cover	PK196A01

No.	Description	Part #
26	Side Panel - Left	IB204A01
28	SMPS	EG048A01
29	Main PCB	EB158A01
30	Door Hinge	IJ001A01
32	3-Way Dispense SV	EC033A01
35	Hot Tank	TB023A01
44	Top Lid	PA034A01
65	Caster	IJ003A01
80	Rear Panel	IB210A01
85	Cold Water Pump	EE023A01
89	XL1 Booster Pump	EE012A01
95	Side Panel - Right	IB205A01
Not Shown	TDS Sensor	EJ033A01

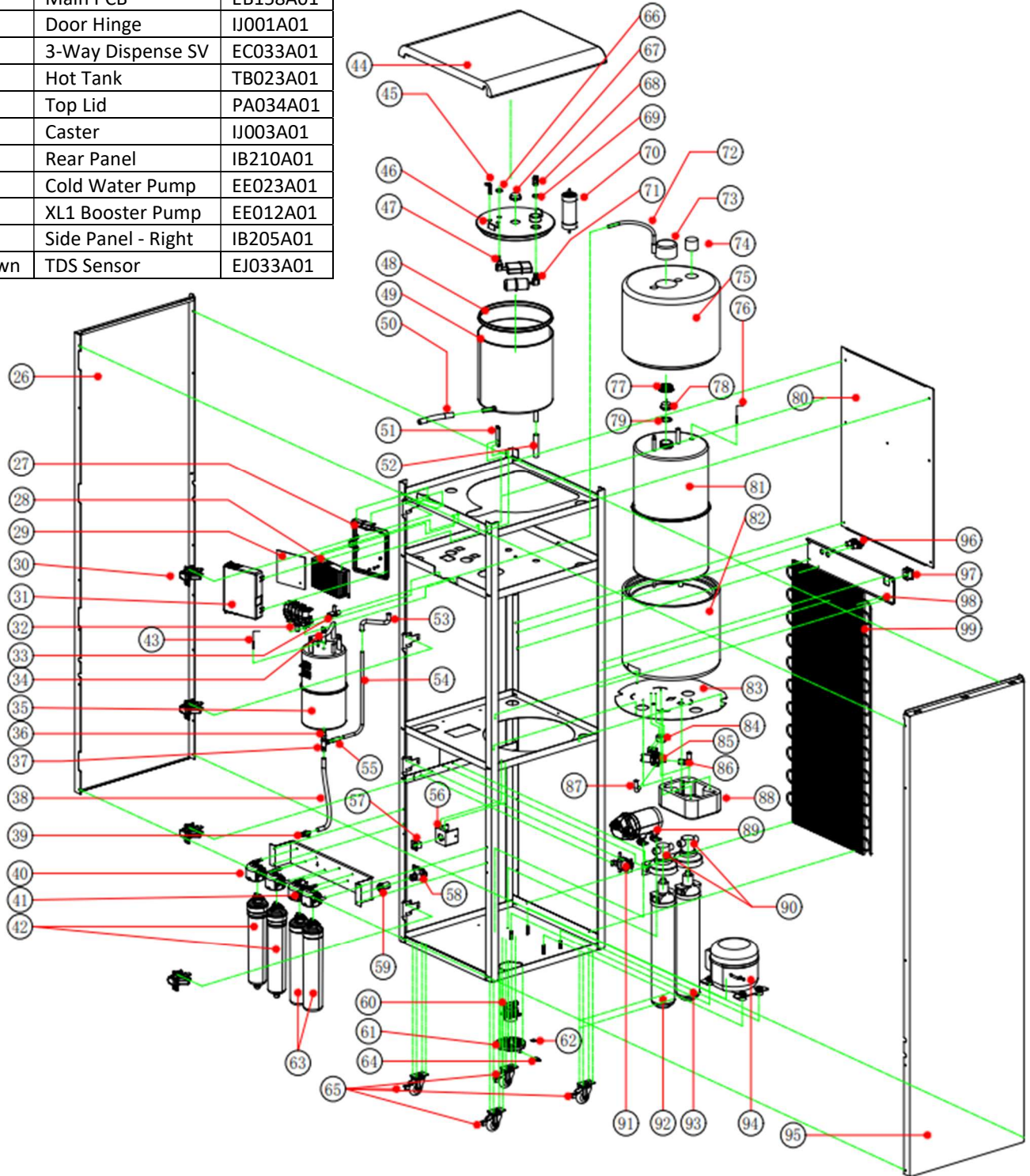

XL1 WATER FLOW DIAGRAM

1	Pre-Filter	1	PF120401
2	Pre-Filter	1	PF120401
3	Pre-Filter	1	PF120401
4	Pre-Filter	1	PF120401
5	Pre-Filter	1	PF120401
6	Pre-Filter	1	PF120401
7	Pre-Filter	1	PF120401
8	Pre-Filter	1	PF120401
9	Pre-Filter	1	PF120401
10	Pre-Filter	1	PF120401
11	Pre-Filter	1	PF120401
12	Pre-Filter	1	PF120401
13	Pre-Filter	1	PF120401
14	Pre-Filter	1	PF120401
15	Pre-Filter	1	PF120401
16	Pre-Filter	1	PF120401
17	Pre-Filter	1	PF120401
18	Pre-Filter	1	PF120401
19	Pre-Filter	1	PF120401
20	Pre-Filter	1	PF120401
21	Pre-Filter	1	PF120401
22	Pre-Filter	1	PF120401
23	Pre-Filter	1	PF120401
24	Pre-Filter	1	PF120401
25	Pre-Filter	1	PF120401
26	Pre-Filter	1	PF120401
27	Pre-Filter	1	PF120401
28	Pre-Filter	1	PF120401
29	Pre-Filter	1	PF120401
30	Pre-Filter	1	PF120401
31	Pre-Filter	1	PF120401
32	Pre-Filter	1	PF120401
33	Pre-Filter	1	PF120401
34	Pre-Filter	1	PF120401
35	Pre-Filter	1	PF120401
36	Pre-Filter	1	PF120401
37	Pre-Filter	1	PF120401
38	Pre-Filter	1	PF120401
39	Pre-Filter	1	PF120401
40	Pre-Filter	1	PF120401
41	Pre-Filter	1	PF120401
42	Pre-Filter	1	PF120401
43	Pre-Filter	1	PF120401
44	Pre-Filter	1	PF120401
45	Pre-Filter	1	PF120401
46	Pre-Filter	1	PF120401
47	Pre-Filter	1	PF120401
48	Pre-Filter	1	PF120401
49	Pre-Filter	1	PF120401
50	Pre-Filter	1	PF120401
51	Pre-Filter	1	PF120401
52	Pre-Filter	1	PF120401
53	Pre-Filter	1	PF120401
54	Pre-Filter	1	PF120401
55	Pre-Filter	1	PF120401
56	Pre-Filter	1	PF120401
57	Pre-Filter	1	PF120401
58	Pre-Filter	1	PF120401
59	Pre-Filter	1	PF120401
60	Pre-Filter	1	PF120401
61	Pre-Filter	1	PF120401
62	Pre-Filter	1	PF120401
63	Pre-Filter	1	PF120401
64	Pre-Filter	1	PF120401
65	Pre-Filter	1	PF120401
66	Pre-Filter	1	PF120401
67	Pre-Filter	1	PF120401
68	Pre-Filter	1	PF120401
69	Pre-Filter	1	PF120401
70	Pre-Filter	1	PF120401
71	Pre-Filter	1	PF120401
72	Pre-Filter	1	PF120401
73	Pre-Filter	1	PF120401
74	Pre-Filter	1	PF120401
75	Pre-Filter	1	PF120401
76	Pre-Filter	1	PF120401
77	Pre-Filter	1	PF120401
78	Pre-Filter	1	PF120401
79	Pre-Filter	1	PF120401
80	Pre-Filter	1	PF120401
81	Pre-Filter	1	PF120401
82	Pre-Filter	1	PF120401
83	Pre-Filter	1	PF120401
84	Pre-Filter	1	PF120401
85	Pre-Filter	1	PF120401
86	Pre-Filter	1	PF120401
87	Pre-Filter	1	PF120401
88	Pre-Filter	1	PF120401
89	Pre-Filter	1	PF120401
90	Pre-Filter	1	PF120401
91	Pre-Filter	1	PF120401
92	Pre-Filter	1	PF120401
93	Pre-Filter	1	PF120401
94	Pre-Filter	1	PF120401
95	Pre-Filter	1	PF120401
96	Pre-Filter	1	PF120401
97	Pre-Filter	1	PF120401
98	Pre-Filter	1	PF120401
99	Pre-Filter	1	PF120401
100	Pre-Filter	1	PF120401

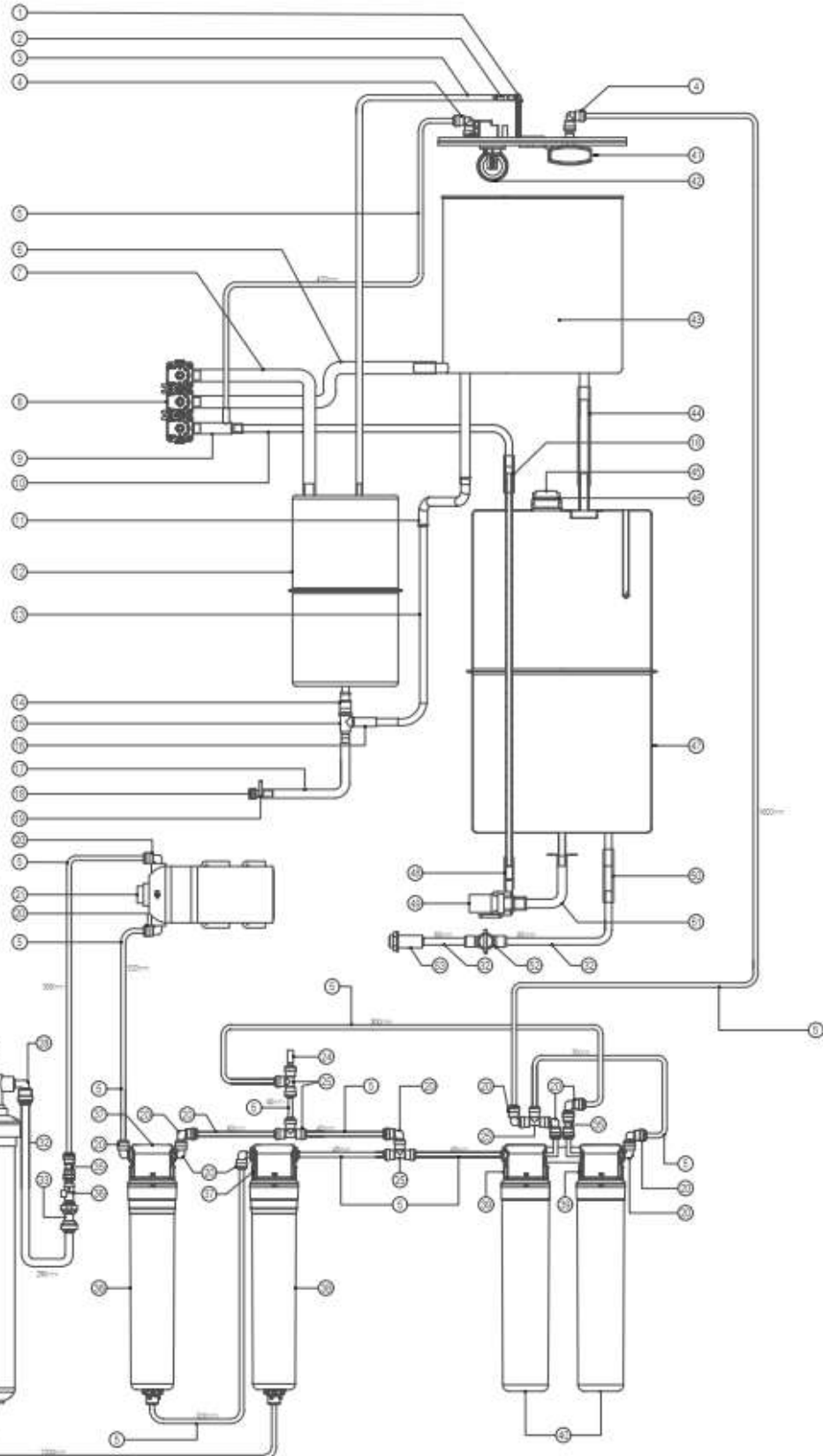

XL1 CONSTRUCTION

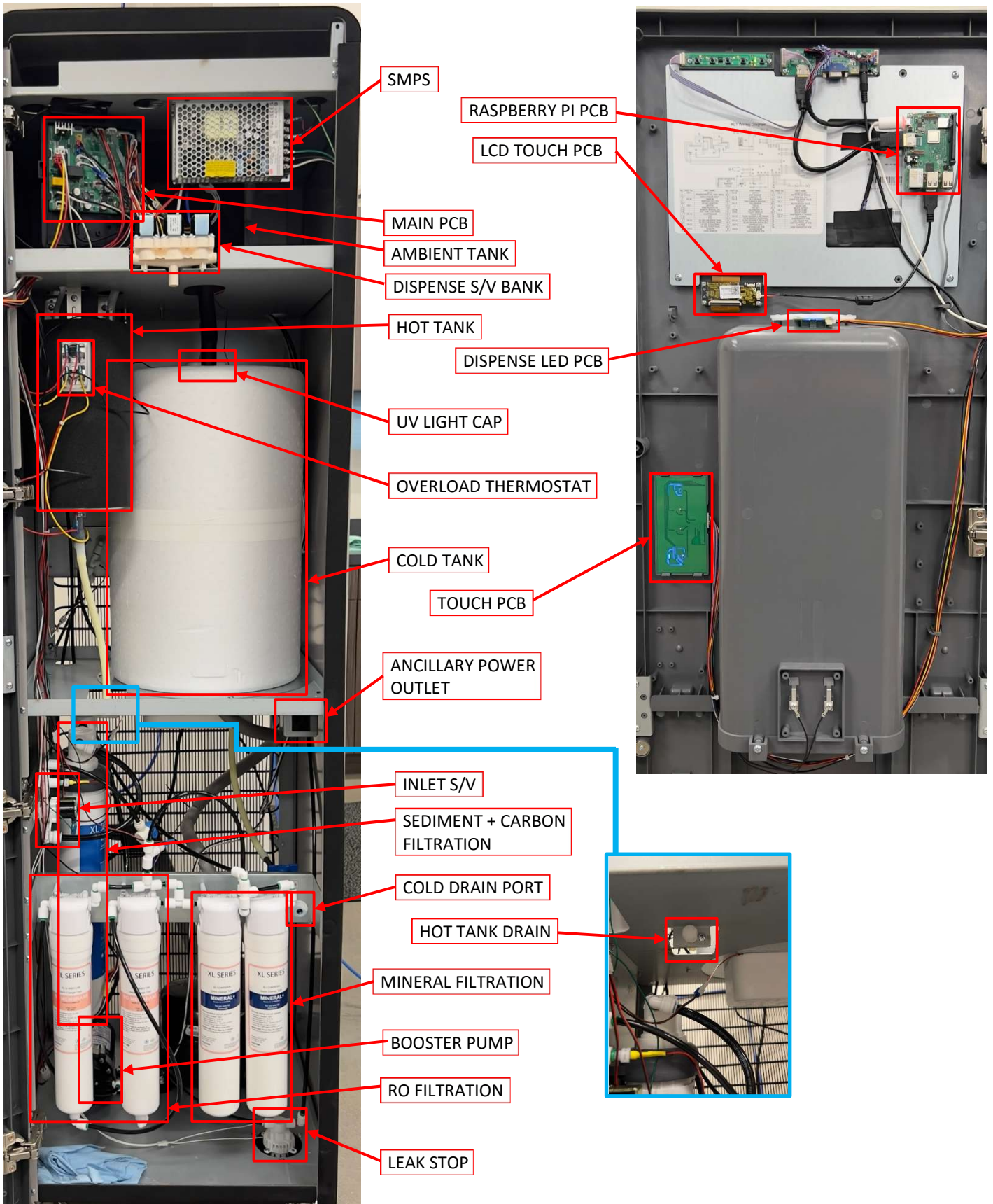

PRE-INSTALLATION



DANGER! ELECTRICAL SHOCK HAZARD.

*Only qualified personnel who have read and understand this entire manual should attempt to install, or service this **XL1 Water Dispenser**, failure to do so could result in death or serious injury. DO NOT plug into an electrical supply until specifically instructed.*



WARNING! ALWAYS SANITIZE BEFORE USE.

Sanitize before use to eliminate any potential microbiological contaminants.

Materials Needed:

- Personal Protective Equipment. Rubber or Nitrile Safety Gloves and Protective Eyewear
 - Phillips Screwdriver
 - Water Pitcher or Container to collect water from the faucet
 - 5-gallon container or drain basin
 - Sanitizer – Vital Oxide Full Strength is recommended
 - ¼" LLDPE Tubing (black recommended) Plastic Tubing – Length dependent on installation.
 - ¼" Quick Connect 90° Stem Elbows (recommended, not required)
 - 3/8" LLDPE Tubing (black recommended), 3-4 feet
 - TDS Meter & Temperature Gauge
1. Unpack the **Wellsys XL1 Water Dispenser** and check exterior for damage.



CAUTION! FILTER FLUSH REQUIRED.

XL1's Water Dispensers are supplied with filters. The frequency of filter changes depends upon your water quality and your water usage. For example, if there is a lot of sediment and/or particles in your water, then you will have to change your filters more frequently than a location with little to no sediment. Be sure to replace your filters whenever you notice a decline in the performance, whether it is a drop of flow rate and/or pressure or an unusual taste in the water.

2. Flush filters thoroughly per filter manufacturers' recommendation with fresh water to drain. More details provided in the **Filter Flushing** section further down.

NOTE: Filters should not be flushed prior to 24 hours before installation to limit Microbial Growth inside of filters.

NOTES ON INSTALLATION

1. Do not install the product at the following locations:
 - Near Fires
 - Near Flammables
 - In Humid Places
 - In front of air conditioners
 - Where exposure to rain or snow is possible
 - Outdoors or in direct sunlight
 - Near chemicals (volatile materials, organic solvents, etc.)
 - Near toilets
 - Anywhere the temperature may fall below 50°F.
2. Use source water within following quality range:
 - Water pressure: 50-70psi
 - Water temperature: 39-100°F (4-38°C)
 - Turbidity: 0.5 NTU or less
 - pH: 5.8-8.5
 - Hardness: 300ppm or less
 - Water Quality: Water quality meeting the Drinking Water Quality standard

*Please consult your distributor if source water quality is out of the specified range.

*The warranty will be void if the product is connected to source water that is out of the specified range.

*This product is not equipped with internal filtration. It is intended to be connected only to a potable water source.

3. When transporting the product, do not tilt it more than 45° from vertical.
 - *Severe tilting can cause a performance degradation.
4. Install the product on a flat surface and adjust the level of the unit using a level gauge.
 - *If the product is tilted more than 3°, overflow may occur.
5. Source water should not be above 100°F (38°C)
 - *Hot water may cause performance degradation or system failure.
6. Keep the sides and rear of the unit at least 5 inches (127mm) away from walls or other objects for ventilation.
7. Do not bend the source water or drain hose or place heavy objects on them.
 - *If either are blocked, the water will not flow smoothly to and from the unit, and may cause performance degradation.
8. Do not place any heating system near the rear of the unit.
9. The power supply, source water, and drain must be directly connected to the unit.

UNPACKING THE UNIT

Unpack the unit and remove all plastic wrap, foam, and protective film from the unit. Follow the steps below to safely unpack the unit. It is **HIGHLY RECOMMENDED** that two people unpack the unit, as it's weight and height make it difficult to remove from the foam pad it travels on before installation.

1. **Remove the straps and box.** Cut the straps holding the box and foam pad together and remove, along with the edge protection. Slide the box up and off the unit. If ceiling clearance is too low to do this, use a box cutter at the **BACK** of the unit and **CAREFULLY** cut the box open along a corner to remove. **DO NOT** attempt to tilt the machine to remove the box.
2. **Remove any plastic coverings.** Remove the plastic bag from the unit and peel away any protective film on the front of unit.
3. **Remove the foam blocks.** The unit sits on a foam pad during transport, at the bottom of the unit, on both sides, are foam blocks that can be removed. **SLIGHTLY** tilt the unit to the right to remove the left block, and to the left to remove the right block. This will make it easier to work the unit backwards off the foam pad.
4. **Remove the unit from the foam pad.** This can be done alone, but it is **HIGHLY RECOMMENDED** to have a **SECOND** person help, by keeping a foot on the front of the pad and assist while another person rolls the unit off the pad from the back. The pad can try to follow the unit otherwise.

XL1 FILTER FLUSHING PROCEDURE

It is important to flush all filters inside the XL1 unit prior to installation. This will flush any carbon fines and preservative from the filters and extend the life of the filters as well reduce the potential of blockages and improve the quality of the water. ***It is recommended to have a readily available drain OR a 5-gallon bucket for the flushing procedure.**

1. **Open the front door of the unit.** Begin by removing the two screws at the back of the top panel. Lift and remove this panel, then set it aside. Looking at the unit from the rear, remove the screw shown at the top left corner of the door. After removing, the door can be swung open.



2. **Hook up water and electrical cable.** The water connections are clearly marked on the back of unit for “Tap Water” and “RO Drain”. Using ¼” LLDPE tubing (black recommended), connect the “Tap Water” connection to the water source, but leave the supply turned **OFF**, and connect the “RO Drain” connection to the locations drain or to a condensate pump that is connected to the drain. Install the supplied power cord to the back of the unit but **DO NOT** connect to power at this time. ***It is recommended to use ¼” 90° Stem Adapters on the back of the unit when making the water connections.**

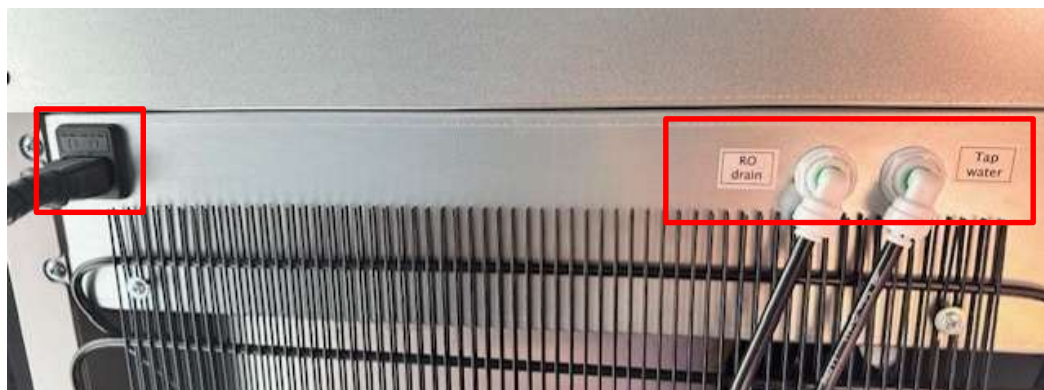

3. **Prepare the RO Filters.** Take new RO membranes and remove any plastic wrap, remove all plugs, caps, and head plugs. Set these aside for now.



4. **Disconnect Power to Booster Pump.** Locate the wire connector circled in **RED** and disconnect. This wire should be hanging just behind the first empty filter head.



5. **Flush the prefilters.** Disconnect the tube connected to the left side of the first filter head (circled in **RED**). Using a ¼" union, add a length of tubing to reach the drain or a 5-gallon bucket to the end of the tubing removed. **Plug the unit into power.** Turn the water supply **ON** and allow 2.5gal of water to flush to drain or into the bucket. Turn the water **OFF**, and then remove the tube extension and **return the tubing to its original position.**



To Drain

6. **Flush the Mineral+ Filters.** Disconnect the tubing from the **OUT** port (right side) of the first head. Insert a 2ft piece of tubing in its place and run this to drain or a bucket. Remove either of the Mineral+ filters from their heads and install into the first head. Turn the water **ON** and flush 2.5gal to drain or into the bucket. Turn the water **OFF**, return the Mineral+ filter to its original head, then repeat the process for the remaining Mineral+ filter. Turn the water **OFF** and return the last Mineral+ filter to its original head and restore the original plumbing of the out port of the left-most filter head.



To Drain

7. **Flush the RO Membranes.** With the water shut **OFF**, disconnect the product line from the fitting circled in **RED** and insert the 2' section of tubing used previously into the fitting, then run this to a drain or bucket. Reconnect the Booster pump wire disconnected earlier, then install the membrane filters into the first and second heads as shown. There are two drain lines that are loose and not connected to anything behind the membranes. The shortest line (connected to the inlet port of the second filter head), connect the loose end to the bottom port of the **FIRST** membrane as shown. Take the second line, which runs to the RO Drain bulkhead, and connect it to the bottom port of the **SECOND** membrane as shown. Turn the water supply **ON**, and allow the unit to produce another 2.5 gallons water into the bucket or drain, then shut the water **OFF**.

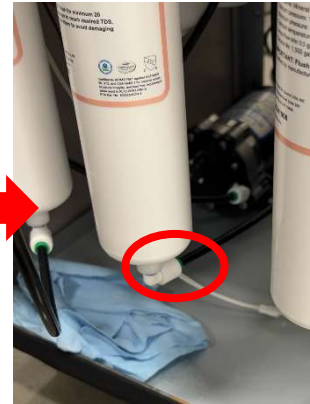
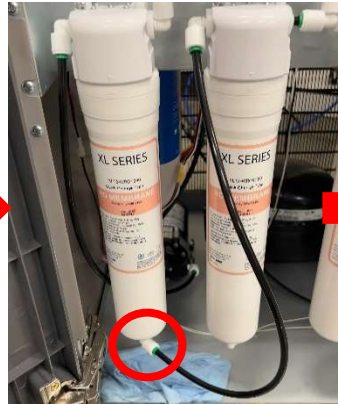
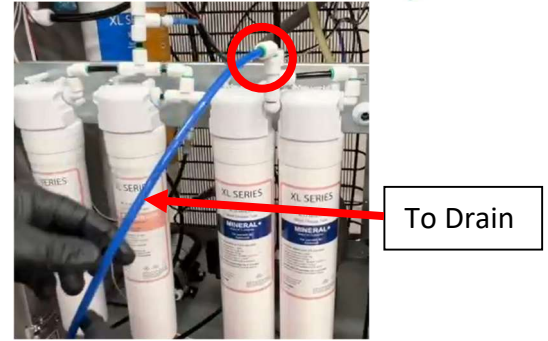

8. **Reconnect Product line to Tanks.** After the unit has produced the 2.5 gallons of water, all filters have now been thoroughly flushed, and the unit can be allowed to run normally. With the water still **OFF**, return the product line to its previous state, inserted into the fitting after the mineral filters, as seen to the right.

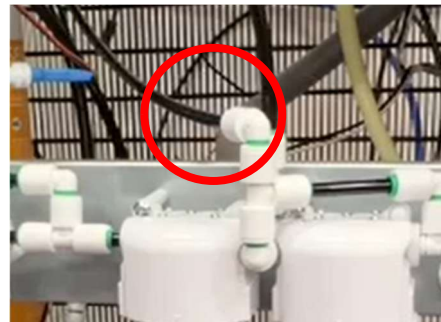

9. **Allow the unit to fill.** Turn the Supply Valve **ON**, and allow the system to begin processing tap water through the RO system and fill the tanks. This can take up to an hour (depending on supply flow).

XL1 SANITIZING PROCEDURE

Before the final steps of installation, it is recommended to SANITIZE the water path of the unit upon installation, and regularly through its service life. The steps below outline how to sanitize a unit that has **previously been installed and connected to water and power**.

1. **Remove top lid and open the door.** If already completed during filter flushing, disregard and proceed to step 2. Begin by removing the two screws at the back of the top panel. Lift and remove this panel, then set it aside. Looking at the unit from the rear, remove the screw shown at the top left corner of the door. After removing, the door can be swung open.



2. **Drain HALF of the total capacity of the unit.** Starting with a full unit, disconnect the unit from power. Connect a 2-foot section of 3/8" LLDPE tubing to the cold drain port (circled in **RED**) of the unit shown to the right, and run this tube to a drain or bucket (shown). Open the ball valve behind the connection port (circled in **GREEN**) and allow 3 gallons of water to drain into the bucket or drain. Close the drain valve when finished.



3. **Add and apply sanitizer to the Ambient Tank.** With the top lid of the unit removed in the previous steps as part of the filter flushing, locate the ambient tank and pull up on the lid to open the top of the tank. Using a spray bottle, spray the inside of the tank and lid with sanitizer (undiluted VitalOxide is the recommended sanitizer). Wipe down the inside of the tank and lid with a lint-free towel. Then, pour 1/2 gallon of sanitizer into the Ambient Tank and re-install the lid. Connect the unit to power and allow it to fill completely. Sanitizer will make it into the Cold Tank naturally.



4. **Clean the front of unit.** Use any remaining sanitizing solution in the spray bottle to clean and wipe down the dispense alcove, drip tray, drip tray grill, and faucet cover.



5. **Sanitize the Dispense Lines and Drain the unit.**

When the unit has filled, dispense 12oz of Ambient water from the front of the unit. Then, do the same with Cold Water. This will introduce sanitizer to the dispense lines. Disconnect the unit from power. With the tubing still connected to the Cold Drain port and running to a bucket or drain, open the drain valve and allow the unit to completely drain the Ambient and Cold tanks (which will be about 7.5 gallons, or 1.5 5-gallon buckets worth of water). Close the drain valve when complete.

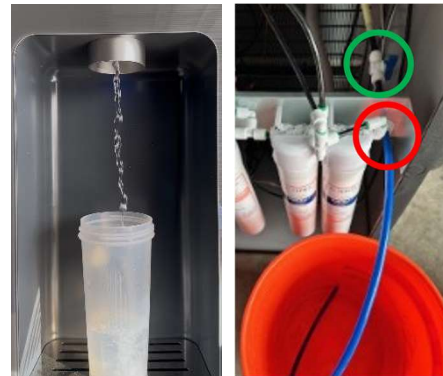

6. **Sanitization Complete, continue to Final Installation.** Ensure the Drain Valve is closed. Remove the section of tubing used for draining. The unit will not begin cooling and heating until after commissioning and it has completely filled. The unit is now ready for final installation steps.

XL1 INSTALLATION

It is very important to follow all instructions listed. Failure to do so may cause the system to not operate properly and may impact the long-term reliability of the system.

1. Always check local plumbing codes before tapping into water supply line and drain line. Tap into the water source with an approved connector.
2. Check incoming water pressure and ensure it is between 50-70PSI. If the water pressure is above 70PSI then a pressure reducing valve must be installed and set to lower the pressure to the optimal water pressure between 50-70PSI.
3. Determine the best installation location. Consider user convenience, electrical access, and water access. The unit performs optimally if within 2- feet of a cold-water supply line. Connect only to a cold-water supply. Do not install Feed Water Assembly on the Hot Water Line. Do not place unit where it will be exposed to rain, freezing temperatures or direct sunlight.
4. The rear of the unit should be installed at least 2" from any vertical surface to ensure proper air circulation.
5. Check the available power supply to assure proper electrical service. In the U.S., the voltage specification is 110/120V 60Hz. Voltage outside of this specification will affect the system performance.
6. **It is intended and expected that the unit has been sanitized and the filters flushed before continuing to the next step. If either has not been performed prior to installation, please refer to those sections of the manual to carry out those procedures before continuing.**
7. **Hook up water and electrical cable.** The water connections are clearly marked on the back of unit for "Tap Water" and "RO Drain". Using ¼" LLDPE tubing (black recommended), connect the "Tap Water" connection to the water source, but leave the supply turned **OFF**, and connect the "RO Drain" connection to the locations drain or to a condensate pump that is connected to the drain. Install the supplied power cord to the back of the unit but **DO NOT** connect to power at this time. **It is recommended to use ¼" 90° Stem Adapters on the back of the unit when making the water connections.*



7. Turn the water supply **ON**, **THEN** plug the power cord into the power outlet. ***It is very important to turn the water supply on BEFORE connecting to power to prevent the booster pump creating a vacuum in the lines.**

Note: The XL1 **WILL NOT** chill or heat water until the water in the ambient tank has reached the float valve, meaning all tanks have filled to capacity. This can take up to 1 hour depending on supply flow and pressure.

8. **Test Water Temperatures and Flow.** After an hour, dispense hot and cold water. Ensure all functions operate properly. (User will not be able to dispense until the unit has been commissioned, which is outlined on the next page.

XL1 COMMISSIONING

Every XL1 unit must be commissioned before it can be used. This involves inputting the “Brand Code” which will dictate the brand displayed on the main menu. The main screen of the unit cannot be used until this is done. Once a unit has been commissioned, it must be factory reset before a different commissioning code can be input to change the branding.

1. **Input the branding code.** Once the unit is powered on and the front screen comes online, the unit will give a prompt for a branding code. The branding code for the Wellsys XL1 is as follows: **WEL123**. Input this 6-digit code into the prompt, then hit “Confirm”. A welcome message will appear, press “Continue”, and then the main UI screen will come up and the unit is ready for use.

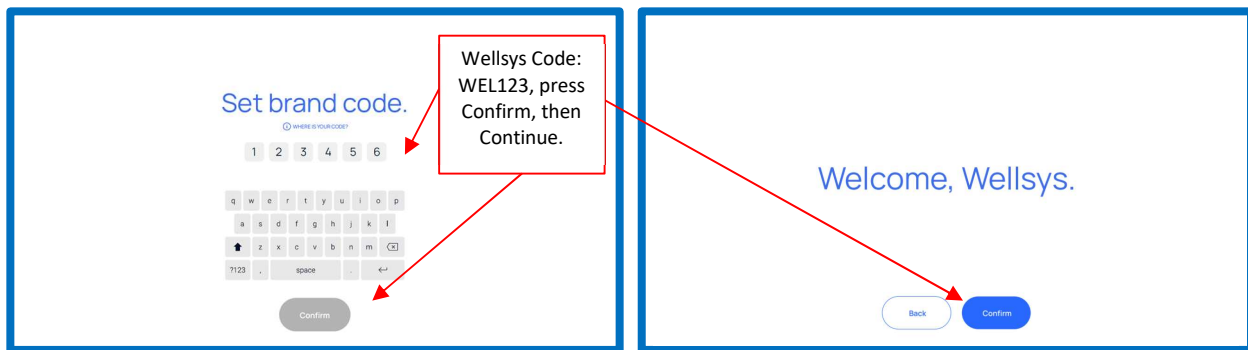

FINAL INSPECTION

After installation and sanitization, verify the following:

1. There are no leaks or loose components.
2. The hot water is over 160°F.
3. The cold water is below 50°F.
4. Confirm acceptable product water flow.
5. If the system is not filling, then check the water supply and also make sure the leak stop has not been tripped. ***The leak stop can be reset by removing the cap below the unit and draining the water out.**
6. Ensure the systems exterior is clean and all components are in place.

Other items to check:

1. Once the system has been flushed it should remain plugged in and water should, at a minimum, be dispensed occasionally. ***Avoid storing in your vehicle or warehouse with residual water in the tank, this will result in a bad taste after installation.**
2. Always drain the system before moving it. It is not necessary to drain the hot tank completely if installing the same day. Leaving water in the hot tank will allow you to turn the hot tank on immediately after installation of the system but if left overnight may result in a taste complaint.
3. **NEVER** lay the system on its side.

RESETTING THE HOT TANK OVERLOAD THERMOSTAT

In the event of a “dry heat” scenario during installation, or if the water supply is blocked to the hot tank, overload thermostats are installed on the Hot Tank to prevent an unsafe heating situation and prevent damage to the unit. If these thermostats sense heat that is too high, they will trip and break the power circuit to the heating element. When this happens, the Overload Thermostat must be manually reset.

CAUTION!: Disconnect the machine from its power source before attempting the next steps. Failure to do so could cause electrical shock.

To do this, open the front door of the unit and locate the hot tank. On the surface of the hot tank, where a section of insulation is cut away, the overload thermostat is mounted to the metal round of the tank. There is a small red/pink button in the center of the thermostat that must be pressed to reset the thermostat. Doing so will restore a continuous path for power to reach the heating element. Before doing so, ensure that water dispenses from the unit during the hot water dispense operation. If water flows from the hot tank, the tank is primed and full of water. If water **DOES NOT FLOW** from the Hot Tank, the tank either needs to be primed, or there is a flow issue that must be rectified before proceeding. Continue with resetting the thermostat, then connect the unit to power again. Water will begin heating, and hot water should be available within 5-10 minutes.

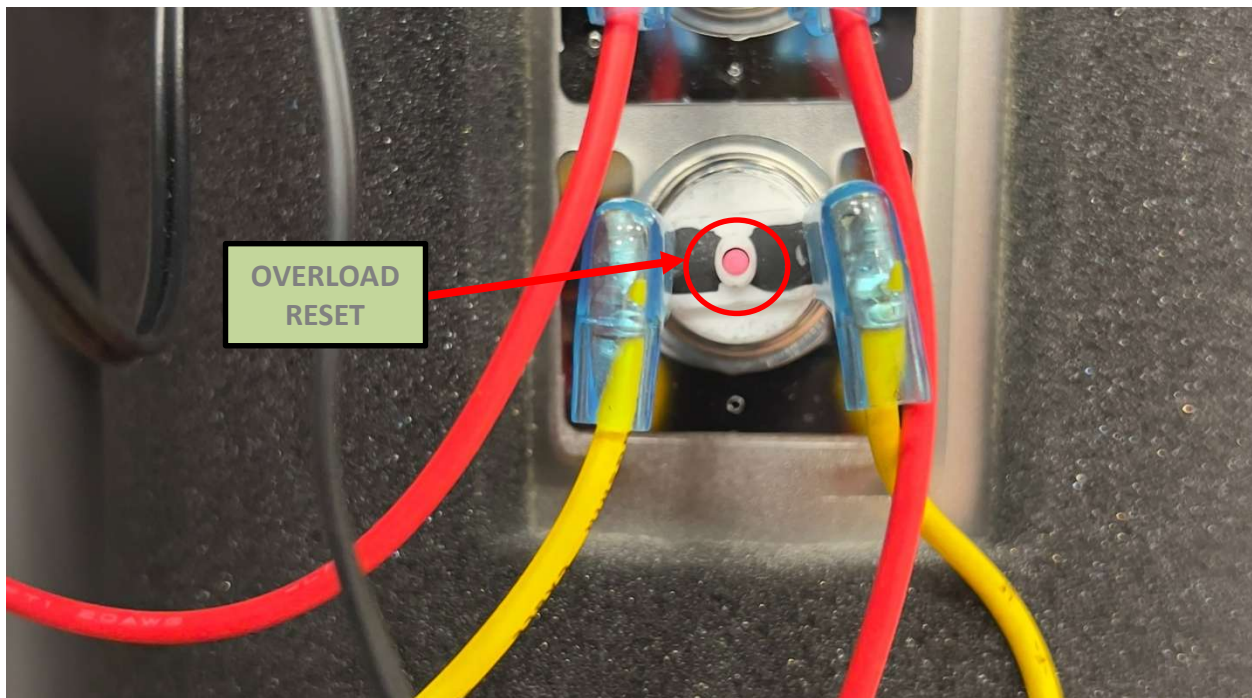

PREVENTATIVE MAINTENANCE

The following is an outline of preventative maintenance that should be performed on yearly or semi-yearly basis to keep the unit running in top shape.

1. Change filters according to the filter change schedule. Always rinse new filters using the same procedure as the original filters.
2. Drain the system and use an approved cleaning agent to sanitize the system as outlined in the sanitization section.
3. Check all fittings for signs of scale or wear and replace as needed.
4. Check solenoids for proper function. Dripping solenoids should be replaced immediately.

Every 5 years, in addition to the above, perform the following:

- Replace all internal fittings and tubing.
- Replace solenoids.

SYSTEM INSPECTION

When changing filters or performing service, the following items should be completed:

- Visual Inspection
- Hose & Fitting Inspection
- Electrical Inspection
- Pressure and Flow Test
- Clean the exterior of system and condenser coils on rear of system.
- Temperature Check (Cold water should be below 50°F, Hot water should be above 160°F)
- TDS Check
- Site Cleanup

WARRANTY PROCEDURE

Procedure for XL1 warranty evaluation:

Contact WELLSYS technical support and provide the following information:

- Serial number
- Failure
- Full details around failure
- Water pressure into the system
- Tap TDS
- TDS out of the cold and hot tanks
- Pictures

Depending on the situation, technical support may request more information. Upon approval, WELLSYS will process warranty credit or replacement part to be fulfilled

XL1 ADVANCED SETTINGS

The XL1 unit has an Admin Menu that can be accessed with a 6-digit numeric code. Many detailed options and settings can be controlled from the Admin Menu. Below is an outline of how to access the menu, and what all of the settings and options control.

Accessing the Admin Menu. To enter the Admin Menu, tap the setting icon (circled in RED) in the upper right corner of the main screen, then enter the code **135790** when prompted. This will take you to the Admin Menu.

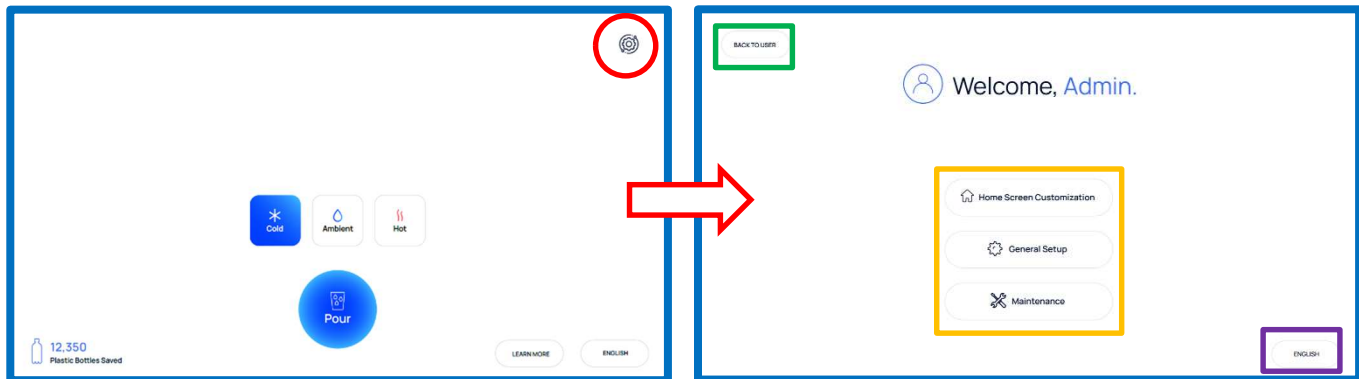

The 3 main settings options (squared in ORANGE) on the Admin Menu are “Home Screen Customization,” “General Setup,” and “Maintenance.” Chose one of these options to continue to that page, or touch the “Back to User” button (squared in GREEN) at any time to return to the main user screen. These settings options will be explained further down in this section. From this Admin Menu page, the display language can also be changed by pressing the “English” button in the lower right corner (squared in PURPLE).

Home Screen Customization

The Home Screen Customization Tab can be used to toggle ON/OFF many different options and metrics that are displayed on the main user interface. The index below explains each option and its function.

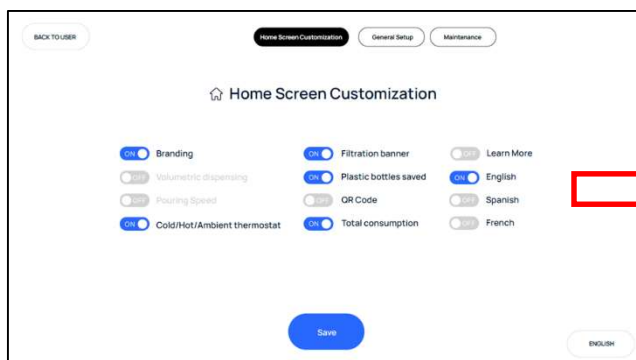

Branding: Toggles the branding on the main screen.
Volumetric Dispensing: Toggles a volumetric counter when pouring.
Pouring Speed: Toggles the two pouring speed options.
Cold/Hot/Ambient Thermostat: Toggles the temperature reading for the different temperature options.
Filtration Banner: Toggles the filtration banner on/off on the main user interface.
QR Code: Toggles a custom QR code at the main user interface. This code can be customized to direct a customer to your website.
Total Consumption: Toggles a bottle counter on the main user interface.

General Setup

The General Setup tab can be used to change the temperature range of the water options, the unit of measure, UV settings, and Hot Tank settings.

Temperature Range can be used to control the temperature range of both hot and cold offerings.
 Hot: **167-176°** Hotter: **176-189°** Hottest: **189-194°**
 Cold: **45-41°** Colder: **41-37°** Coldest: **37-35°**

UV Settings can be used to adjust UV timing.
1 Hour on 1: 1 hour on, 1 hour off
1 Hour on 2: 1 hour on, 2 hours off
Always On: UV never turns off.

Hot Tank Settings
Hot Tank Heating: Hot tank functionality can be turned off, if desired.
Energy Saver Mode: Hot tank will turn off after period zero interaction with unit.

Unit of Measure can be toggled between Gallons and Liters.

Will be available to use after next firmware update.

Maintenance

The Maintenance tab can be used to view the filters installed and their statuses, usage of the unit, and TDS readouts. The unit can also be **Factory Reset** from the maintenance tab.

Filter Status: Shows Filter Type and which filters have been installed.

FILTER	INSTALLED
Pre Sediment	<input checked="" type="checkbox"/>
Pre Carbon	<input type="checkbox"/>
Ro1	<input type="checkbox"/>
Ro 2	<input type="checkbox"/>
Mineral Post 1	<input type="checkbox"/>
Mineral Post 2	<input type="checkbox"/>
Carbon Block 1 (Non Ro)	<input type="checkbox"/>
Carbon Block 2 (Non Ro)	<input type="checkbox"/>

Filter Remaining: Shows Filter max life in gallons and months, and remaining Filter life %. Filter Alerts can be toggled for individual filters.

GALLONS	TIME	PERCENTAGE	FILTER ALERT
20,000	24 months	100%	<input checked="" type="checkbox"/>
20,000	24 months	100%	<input type="checkbox"/>
5,000	36 months	55%	<input type="checkbox"/>
5,000	36 months	23%	<input type="checkbox"/>
2,500	24 months	10%	<input type="checkbox"/>
2,500	24 months	55%	<input type="checkbox"/>
3,000	24 months	100%	<input type="checkbox"/>
3,000	24 months	100%	<input type="checkbox"/>

Actual Filter Usage: Shows water through filters in gallons and length of time since install.

GALLONS	TIME	Reset
250 Gal	6 months	Reset Enter
250 Gal	6 months	Reset Enter
125 Gal	6 months	Reset Enter
125 Gal	6 months	Reset Enter
50 Gal	6 months	Reset Enter
50 Gal	6 months	Reset Enter
OFF	6 months	Reset Enter
OFF	6 months	Reset Enter

System Status: TDS input value Read Out, TDS product value Read Out, Error reads out List Code Errors.

Factory Reset Button: Shows Filter Type and which filters have been installed.

TDS reading Pre and Post filtration. Any system errors will display here as well.

TROUBLESHOOTING INDEX

1. No water or Slow Production (Hot/Cold/Ambient)
2. Hot Water Dispense produces water that is not hot
3. Display is unlit, unit not operating
4. Dispense operation does not dispense water (any temperature)
5. Cold Water not cold

1. No water or Slow Production (Hot/Cold/Ambient)

Possible Cause	Solution
Check Water Production after Filtration Bank	Ensure water is pushing past the filters. If flow is slow or stopped after filters, one or more filters may be plugged and will need to be replaced. Also check that the booster pump is running. A failed pump could cause very low flow through the filtration system.
Check the Leak Stop	If water gets into the bottom of the system, then the leak stop will shut off the water supply. Drain any water from the leak stop using the plug on the back of the unit. The water line AFTER the leak stop may need to be disconnected then reconnected to break any vacuum that may have developed in the line.
Supply Water Pressure	Check the water pressure into the filter bank and confirm adequate pressure, should be 50-70psi. Ensure the ¼"-turn valve just before the filtration system is open.

2. Hot Water Dispense produces water that is not hot

Possible Reason	Solution
Overload Thermostat Tripped	Locate the Overload Thermostat mounted on the front of the hot tank. Press the red button to manually reset the thermostat and return the hot tank power circuit to normal operation.
Hot Tank Disabled	In the General Setup menu, ensure the Hot Tank option is activated and enabled.

3. Display is unlit, unit not operating

Possible Reason	Solution
Power Cord Disconnected	Ensure the power cable is properly plugged into the wall power outlet.
Tripped GFCI	Reset GFCI outlet.
Screen Connection Error	Check the connection of the main ribbon cable to the UI screen.

4. Dispense operation does not dispense water (any temperature)

Possible Reason	Solution
Touch Screen PCB Failure	Touch Screen PCB may have failed, or become disconnected from touch screen. Check connection.
Dispense Solenoid	If one water selection dispenses and another does not, check corresponding dispense solenoid for failure. Solenoids can sometimes “stick” open and become very hot to the touch. Replace in either case.

5. Cold Water not cold

Possible Reason	Solution
Compressor Issue	If compressor will not engage, or is too hot to touch, contact Technical Support.