

PRODUCT SUPPORT

- ELECTRICAL COMPONENT TROUBLESHOOTING -

December 19, 2023

WS12000-i12-WL900 Electrical Component Troubleshooting Guide

Purpose:

To aid in the troubleshooting of fault codes and sensors between the (3) machines.

Table of Contents:

Page: 1 - 4	WS12000 Troubleshooting
Page: 5 - 8	i12 Troubleshooting
Page: 9 - 11	WL 900 Troubleshooting
Page: 12	Testing Tray Motor Switch
Page: 13 - 14	Testing Ambient Level Sensor
Page: 15	Testing Temp Sensors
Page: 16	Testing Cold Level Sensor
Page: 17	Testing Compressor Amp Draw
Page: 18	Testing Hot Gas Solenoid

WS12000 Troubleshooting Guide

Issue	Symptom	Cause	Repair
Multiple blinking lights and an alarm	Unit not filling, heating or cooling water	Unit in drain mode	Turn off drain mode switch in filter compartment
Blinking Ice full light	No ice	Faulty Ice making sensor	Disconnect and do not replace sensor
		Faulty surrounding temp sensor	Test resistance value of sensor and replace if necessary
		Cold tank not filling in 5 minutes/ power to solenoid	Check for a blockage, check cold inlet solenoid for 24VDC, if power is present replace solenoid
		Cold tank not filling in 5 minutes/no power to solenoid	Check cold water level sensor and replace if necessary. If cold water level sensor is ok, replace board.
		Faulty coupler micro switch	Check for continuity at each switch and replace if necessary
		Board	Replace board
Blinking water full light and alarm	Over filled ambient tank	Make sure water supply is going to the correct bulkhead	Water supply should go to the bottom bulkhead
		Solenoid stuck open (water flows through even when there is no power)	Test and replace if necessary
		Bad ambient water level sensor (water level above dots and power is still going to inlet solenoid)	Replace if necessary
Blinking cold light	No ice or cold water	Cold sensor	Test resistance value of sensor and replace if necessary

WS12000 Troubleshooting Guide Cont.

No Ice	No blinking lights/ ice button not lit	Ice function turned off	Turn ice light back on by holding the "ice lock" button down for 10 secs.	
	No blinking lights/ lock lit	Water and ice dispensing locked	Turn off lock function by holding "ice lock" button for 3 secs.	
	No blinking lights/cold water functional	Broken coupler/frozen ice tray/water at or below 40 degrees	Replace hot gas solenoid coil and coupler	
	No blinking lights/ water full light not lit	Check if water level is below the mid-point on the water level sensor	Check water source and replace filters if necessary	
	Ice present in bin, but dispense wheel will not spin	Bad dispense motor	Replace dispense motor (behind Hot tank)	
	Cold water will not go to 40 degrees	Ice making sensor		Disconnect and do not replace sensor
		Cold sensor		Test resistance value of sensor and replace if necessary
		Sensors function correctly, board not sending power to the compressor		Replace PCB
		Compressor hot to touch		Check compressor amperage for LRA (locked rotor amps), 9.8amps.
		Cold temp above 40 degrees and will not come down.		Check compressor amp draw. 1.1 - 2 amps normal operating range

WS12000 Troubleshooting Guide Cont.

No ice or cold water	Broken Coupler/no blinking lights	Faulty cold sensor	Test resistance value of sensor and replace if necessary
		Faulty Ice making sensor	Disconnect and do not replace sensor
	Coupler intact/ no blinking lights	Check leak detector	Check for vapor lock, or locate and repair leak
		Check if water level is below the mid-point on the water level sensor	Check water source, leak detector or replace filters if necessary
		Check cold temp, cold needs to be at 40 degrees to make ice	Sensors function correctly, replace board
			Check compressor amp draw. 1.1-2 amps normal operating range
		Cold tank not filling in 5 minutes/ power to solenoid	Check for a blockage, check cold inlet solenoid for 24VDC, if power is present replace solenoid
	Cold tank not filling in 5 minutes/no power to solenoid	Check cold water level sensor and replace if necessary. If cold water level sensor is ok, replace board.	
Water dripping from Ice dispense area	Ice bin full of ice and water	Ice bin drain clogged	Replace drain line with new 3/8" tubing

WS12000 Troubleshooting Guide Cont.

Water dripping from Ice dispense area	Ice bin full of ice and water	Ice bin drain clogged	Replace drain line with new 3/8" tubing
Ghost dispense	Ice	Ice bin door solenoid broken	Replace
	Water	Dispense valve stuck open	Check for 24VDC at solenoid, if no voltage replace valve/voltage check board or touch sensors
	Ice and or water	Bad touch sensor	Replace top panel
Hot not hot	No blinking light	Hot light turned off	Turn hot on
		Check leak detector	Check for vapor lock, or locate and repair leak
		Check if water level is below the mid-point on the water level sensor	Check water source and replace filters if necessary
	Blinking lights	Unit in error mode	Will not produce hot water, clear error
	No blinking light no voltage present at element	No voltage at board	Replace board
		Tripped bimetal	Reset or replace bimetal
	No blinking light, voltage present at element	Bad heating element	Replace hot tank

i12 Troubleshooting Guide

Issue	Symptom	Cause	Repair
"Refilling Ice Bin LED" Blinking	No ice and no cold water	Open Circuit / Failure	Place unit in Self-Diagnostic Mode to confirm failed component.
		Cold Temp Sensor	Place unit in Self-Diagnostic Mode to confirm failed component.
	Cold Water level not detected	Cold tank not filling in 5 minutes/ power to solenoid	Check for a blockage, check cold inlet solenoid for 24VDC, if power is present replace solenoid
		Cold tank not filling in 5 minutes/no power to solenoid	Check cold water level sensor in Self-Diagnostic Mode and replace if necessary. If cold water level sensor is ok, replace board.
	Ice Tray Location not detected	Micro Switch(Ice Tray making & releasing point) is not reached for 60 sec.	Place unit in Self-Diagnostic Mode to confirm failed component. Ensure Ice Tray Coupler is not broken.
	Cooling Operation not operating	The cold-water target temperature is not reached within 60 min.	Ensure circulation pump is working, if working, check cold water temperature and if it is cool but not cold, check compressor temperature and general operation, if compressor is working, replace hot gas solenoid
		If there is no variation of cold-water temperature for 15 min. during cooling and ice making operation	
	Abnormal Occurrence during the Ice making operation	If the ice making operation is completed 3 consecutive times below the expected time which is calculated by the Surrounding Temperature Sensor, Then the system will recognize as "Over Cooling"	Check the ice tray coupler, if not broken, unplug the unit and disconnect the Ice Temp Sensor (C6 on the PCB) then power the unit back up, if still no ice (first ice batch can take up to 30 min), then check the cold sensor and circulation pump

i12 Troubleshooting Guide Cont.

"Refilling Water LED" Blinking	Over filled ambient tank	Make sure water supply is going to the correct bulkhead	Water supply should go to the bottom bulkhead
		Solenoid stuck open (water flows through even when there is no power)	Test and replace if necessary
		Bad ambient water level sensor (water level above dots and power is still going to inlet solenoid)	Place unit in Self-Diagnostic Mode to confirm failed component.
"Refilling Ice Bin LED & Cold Select LED" Blinking	Cold & Surrounding Temperature Failure	Cold & Ice making operations OFF	Place unit in Self-Diagnostic Mode to confirm failed component.
"Cold Water Select LED" Blinking	Open Circuit / Close Circuit Failures	Cold Temperature Sensor	Place unit in Self-Diagnostic Mode to confirm failed component.
"Ambient Water Select LED" Blinking	Open Circuit / Close Circuit Failures	Surrounding Temperature Sensor	Place unit in Self-Diagnostic Mode to confirm failed component.
"Hot Water Select LED" Blinking	Open Circuit / Close Circuit Failures.	Ice Temp Sensor	Disconnect Ice Temp Sensor (C6 on PCB)
Multiple blinking lights and an alarm	Unit not filling, heating or cooling water	Unit in drain mode	Turn off drain mode switch in filter compartment
No ice	No blinking lights/ water filling light lit	Check if water level is below the mid-point on the water level sensor	Check and replace filters if necessary
	No blinking lights/cold water functional	Broken coupler/frozen ice tray	Check and replace hot gas solenoid coil and coupler
	Ice present in bin, but dispense wheel will not spin	Bad dispense motor	Replace dispense motor (behind Hot Tank)
	Cold water will not go to 40 degrees	Cold sensor	Place unit in Self-Diagnostic Mode to confirm failed component.
		Sensors function correctly	Replace PCB
		Cold temp above 40 degrees	Check compressor amp draw. 1.1 - 2amps normal operating range

i12 Troubleshooting Guide Cont.

No ice or cold water	Broken Coupler/ no blinking lights	Faulty cold temp sensor	Place unit in Self-Diagnostic Mode to confirm failed component.
		Faulty Ice making sensor	Disconnect and do not replace sensor
		Cold tank not filling in 5 minutes/ power to solenoid	Check for a blockage, or replace cold inlet solenoid
		Cold tank not filling in 5 minutes/ no power to solenoid	Check cold tank level sensor and replace if necessary
	Coupler intact/ no blinking lights	Check leak detector	Check for vapor lock, or locate and repair leak
		Check if water level is below the mid-point on the water level sensor	Check and replace filters if necessary
			Sensors function correctly, replace board
		Check cold temp, cold needs to be at 40 degrees to make ice	Check compressor amp draw. 1.1 - 2amps normal operating range
Water dripping from Ice dispense area	Ice bin full of ice and water	Ice bin drain clogged	Replace drain line with new 3/8" tubing

i12 Troubleshooting Guide Cont.

Ghost Dispense	Ice	Ice bin door solenoid broken	Replace
	Water	Dispense valve stuck open	Check for voltage at solenoid, if no voltage replace valve/voltage check board or PSD sensors
	Ice or water	Bad PSD sensor	Replace top panel
Hot not Hot	No blinking light	Check if water level is below the mid-point on the water level sensor	Check water source and replace filters if necessary
	Blinking lights	Unit in error mode	Place unit in Self-Diagnostic Mode to confirm failed component.
	No blinking light no voltage present at element	No voltage at board	Replace board
		Tripped bimetal	Reset or replace bimetal
No blinking light voltage present at element	Bad heating element	Replace hot tank	

Self-Diagnostic Mode – i12

1) How to enter: Unplug the unit, wait 10 seconds, and power back on. Within 5 min. after the power being supplied, hover over the “Water Dispense” & “Ice Dispense” PSDs simultaneously for 5 sec or until all the lights come on. NOTE: the unit will dispense ice and water, so have a small bucket or pitcher on the drip tray to catch ice dispensed. Once entering to the diagnostic mode, all LEDs will turn “ON” , all operations (Purification, Heating, Ice making, cooling) will be stopped.

2) To begin diagnostics: Hover over the “Ice Dispense” (all LEDs turn off), “Temp Select” , and “Water Dispense” PSD’ s, one at a time. Then hover over the “Water Dispense” PSD sensor two times, the water drop will change color each time, stop when the the water drop turns red, then hover over the ice dispense PSD once. Pause for 30 seconds while unit runs a diagnostic test, then the unit will alert to any stored errors by blinking the failure related LEDs.

3) Exiting Self Diagnostic Mode: Unplug the unit, wait 10 seconds and power it back up.

4) Video: Video showing how to enter Self-Diagnostic Mode located in the Video Library of the Dealer Resource Center.

Error Codes in Service Mode		
Blinking Light	Failed Sensor	Repair
Cold Temp Light	Cold Sensor	Replace Cold Sensor
Ambient Temp Light	Ambient Air Temp Sensor	Replace Ambient Air Temp Sensor
Refilling Water Light	Ambient Water Level Sensor	Replace Ambient Water Level Sensor
Cold & Ambient Temp Lights	Cold & Ambient Sensors	Replace Cold & Ambient Sensors
Refilling Ice Bin	Tray Motor Switches	Replace both Switches

WL900 Troubleshooting Guide

Issue	Symptom	Cause	Repair
Multiple blinking lights and an alarm	Unit not filling, heating or cooling water	Unit in drain mode	Turn off drain mode switch in filter compartment
Blinking Ice Full Light	No ice	Bad ice full sensors	Replace both full ice bin sensors
Blinking Ice Light	No ice	Faulty Ice making sensor	Disconnect and do not replace sensor
		Faulty surrounding temp sensor	Test resistance value of sensor and replace if necessary
		Frozen ice tray	Check and replace Step valve
		Faulty coupler micro switch	Check for continuity and replace if necessary
Blinking water full light and alarm	Over filled ambient tank	Make sure water supply is going to the correct bulkhead	Water supply should go to the bottom bulkhead
		Solenoid stuck open (water flows through even when there is no power)	Replace if necessary
		Bad Ambient water level sensor	Replace if necessary
		Unit was converted to carbon filtration	Add 50psi pressure regulator after post filter and unplug pump
Blinking cold light	No ice or cold water	Cold Sensor	Test resistance value of sensor and replace if necessary
		No water getting into the ice tray	Replace circulation pump
Blinking hot light	No voltage present at element	Tripped bimetal	Reset or replace bimetals
		bad hot sensor	Replace hot sensor
	Voltage present at element	Bad heating element	Replace hot tank

WL900 Troubleshooting Guide Cont.

Blinking Ambient Light	Ambient tank not full	Check water path for component failures	Replace any failed components
	Ambient tank full	Water level above dots on the ambient water level sensor	Replace ambient water level sensor
No ice	No blinking lights/ water full light not lit	Check if water level is below the mid-point on the water level sensor	Check water source and replace filters if necessary
		Check leak detector	Check for vapor lock, or locate and repair leak
	Ice present in bin, but dispense auger will not spin	Bad dispense auger Coupler	Replace coupler and check cold sensor resistance value, replace if necessary.
	Cold water will not go to 40 degrees	Ice making sensor	Disconnect and do not replace sensor
		Cold sensor	Test resistance value of cold sensor and replace if needed
		Sensors function correctly	Replace PCB
		Cold temp not stable and seems to slowly rise	Check compressor amp draw. 1.1 -2amps normal operating range

WL900 Troubleshooting Guide Cont.

Water dripping from Ice dispense area	Ice bin full of ice and water	Ice dispense door stuck open	Replace ice dispense door arm or motor
		Cold tank overflowing into ice bin	Check and replace water level sensor if necessary
Ghost dispense	Ice	Ice dispense door stuck open	Replace ice dispense door arm or motor
	Water	Dispense valve stuck open	Replace
	Ice or water	Bad touch sensor	Replace top panel
Hot water not hot	No blinking light	Check if water level is below the mid-point on the water level sensor	Check water source and replace filters if necessary
	Blinking lights	Unit in error mode	Will not produce hot water, clear error
	No blinking light no voltage present at element	No voltage at board	Replace board
		Tripped bimetal	Reset or replace bimetal
No blinking light voltage present at element	Bad heating element	Replace hot tank	

Test Tray Motor Switch



1. Remove the tray Motor.



2. Disconnect the tray switches from the board.



3. Set your meter to Continuity.



4. Put your test leads across the black and brown wires.



5. Press the micro switches and listen for a beep from your meter.



6. Put your test leads across the black and red wires. Press the switches again and listen for a beep from your [meter](#)

7. If you do not hear a beep from your meter when you press the switches, you have a bad switch and both switches need to be replaced. If you do hear a beep, then you have good switches.

Testing Ambient Water Level Sensor

Visually determine where the water level is to determine which sensor to test.

Wire and Level Sensor Diagram

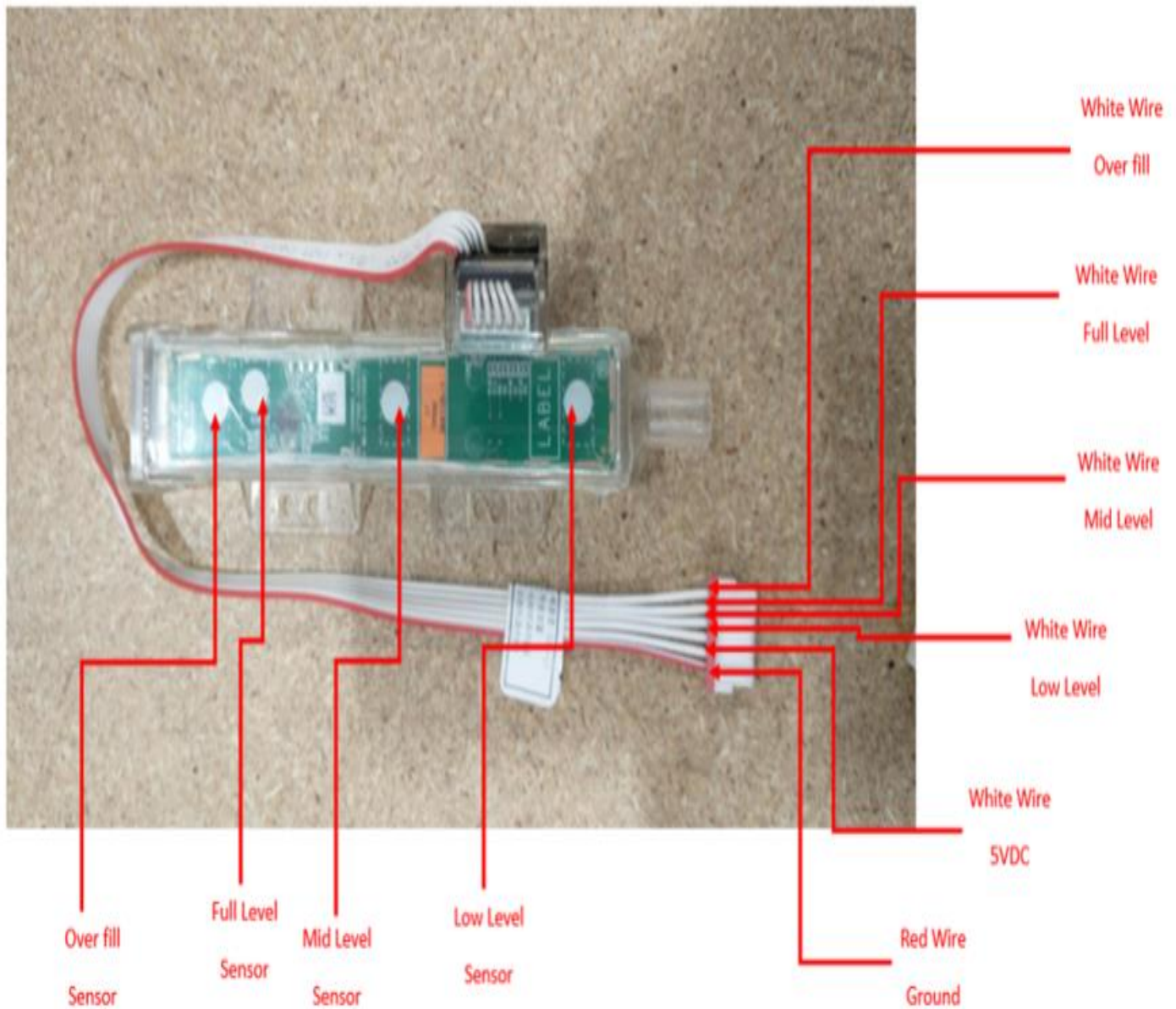

Testing Ambient Water Level Sensor Cont.

To test the Ambient water level sensor, first determine where the actual water level is.

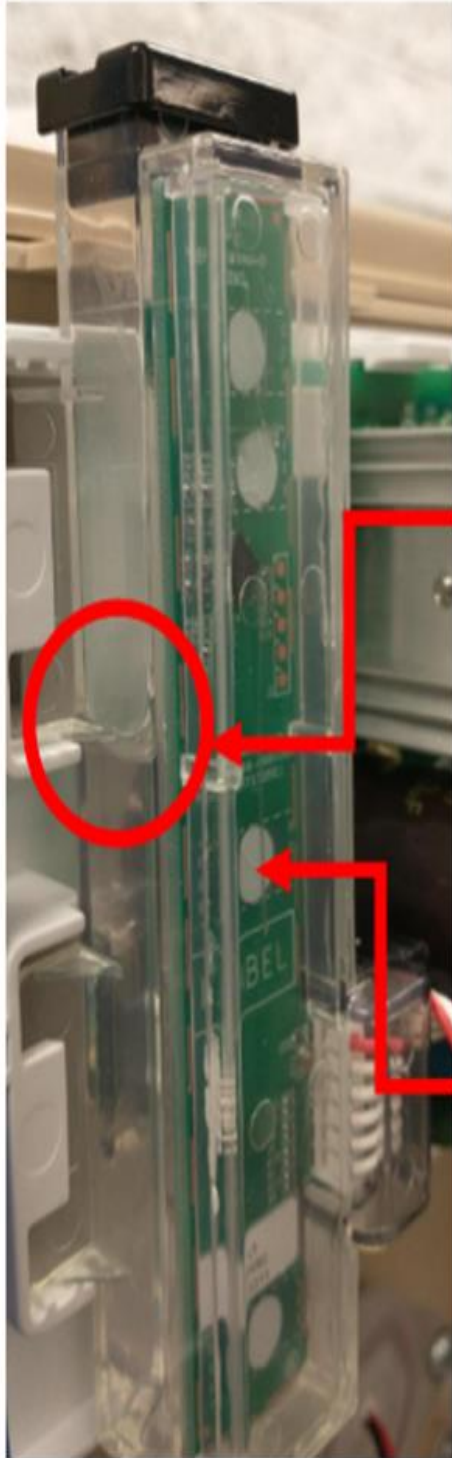

The water level in
this unit is slightly
above
the mid level sensor

Mid Level
Water sensor

Any Sensor that is touching water, will have 5VDC present on the associated wire. If water is touching a sensor and has a reading of 0VDC, this indicates a bad sensor and needs to be replaced. Set your meter to measure DC volts. One probe should be contacting the red wire, and the other Probe should contact a white wire that is associated with the sensor you are testing. Please see the chart below to see which wires are associated with which sensors.



Testing For Resistance Values on Cold Temp & Surrounding Temp Sensors

Testing for Resistance Values on Cold Temp and Surrounding Temp Sensors

Use the chart to determine the resistance value of a sensor based on water or environment temp.

Example: If cold water temp is 41°F, Cold Temp Sensor resistance should be 22.2kΩ

Cold Temp Sensor		Surrounding Temp Sensor WS12000/i12		Surrounding Temp Sensor WL900		Hot Tank Temp Sensor	
Cold Water Temp (F)	K Ohms	Environment Temp (F)	K Ohms	Environment	K Ohms	Hot Water Temp	K Ohms
32°F	27.53kΩ	32°F	161.7kΩ	32°F	13.26kΩ	70°F	12.49kΩ
41°F	22.2kΩ	40°F	141.8kΩ	40°F	11.44kΩ	75°F	10.4kΩ
44.6°F	20.41kΩ	45°F	114.4kΩ	45°F	9.95kΩ	80°F	11.01kΩ
50°F	18.02kΩ	50°F	99.10kΩ	50°F	8.82kΩ	85°F	9.82kΩ
55°F	95.79kΩ	55°F	8.28kΩ	77°F	10kΩ	90°F	8.25kΩ
59°F	14.72kΩ	60°F	83.05kΩ	60°F	7.36kΩ	95°F	7.41kΩ
64.4°F	13.08kΩ	65°F	72.18kΩ	65°F	6.56kΩ	100°F	7.31kΩ
69.8°F	11.64kΩ	70°F	59.67kΩ	70°F	5.79kΩ	105°F	6.56kΩ
75.2°F	10.38kΩ	75°F	49.59kΩ	75°F	5.2kΩ	110°F	5.59kΩ
80.6°F	9.281kΩ	80°F	50.30kΩ	80°F	4.87kΩ	115°F	5.05kΩ
86°F	8.311kΩ	85°F	44.31kΩ	85°F	4.38kΩ	125°F	4.28kΩ
91.4°F	7.457kΩ	90°F	37.03kΩ	90°F	3.89kΩ	175°F	1.80kΩ
95°F	6.944kΩ	95°F	32.68kΩ	95°F	3.51kΩ	185°F	1.52kΩ
100.4°F	6.249kΩ	100°F	31.92kΩ	100°F	3.32kΩ	200°F	1.22kΩ

Instructions

1. Unplug sensor from board (measure cold water temp if testing cold sensor, measure surrounding environment temp if testing surrounding temp sensor)

2. Set your meter to K Ohms - Ω on your self-ranging meter

3. Read resistance with your probe through the bottom of the plug, as pictured.

4. When testing the cold temp sensor, do not measure the resistance of green ground wire on the cold sensor



Testing the Cold Level Sensor

TAKE CAUTION AS THERE IS POWER TO PCB

To test the functionality of the Cold Level Sensor, the unit must be powered on and multimeter **is required**.

1. Gain access to the PCB of the unit you are working on and locate the connection for the Cold Level Sensor on PCB. The location of the Cold Level Sensor connection differs from model to model. Pics of PCB's across all models shown below.

2. Place your multimeter in VDC and, using the probes (**needle point probes recommended**), test across the red and white wires on the connection for the Cold Level Sensor, as shown in FIG 1. **DO NOT TEST FROM THE SOLDER POINTS ON THE PCB, ALWAYS TEST AT THE CONNECTOR**

a. 12000 units will be tested across the brown and red wire

3. On a good Cold Level Sensor, when water reaches the level sensor, the multimeter should show between 4.5 to 5 VDC, and 0 VDC when water has not reached the level sensor.

a. 12000 will have 12VDC when water is present, 7VDC when no water is touching the sensor

4. If the cold tank is full and testing the level sensor results in 0 VDC, the unit will show an error code and will not cool water or make ice - replace level sensor.

5. If the ambient tank is full but the cold tank is empty, test level sensor. A result of 5VDC indicates a bad sensor that is sending a message to the PCB that the cold tank is full. This will trigger the circulation pump to run dry as it attempts to circulate water across the ice fingers. Symptoms that may occur- no ice production and possibly a loud screeching sound similar to worn ball bearings or a circular saw - replace level sensor. Unit will not show any error codes.

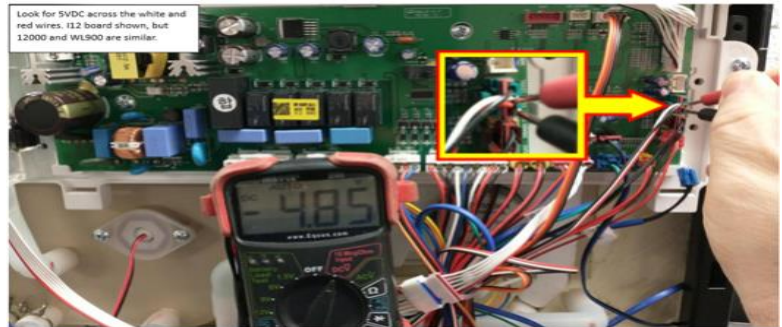

I12 Cold Water Level Sensor







WL900 Cold Water Level Sensor



12000 Cold Water Level Sensor (2018 and up)

Using a Clamp-Style Meter to Test Amperage

TAKE CAUTION WHEN WORKING WITH LIVE WIRES

1	When checking amperage keep hands and fingers behind the clamp meter's tactile barrier (FIG 1.). Do not use clamp meter on bare wires.	FIG 1.	FIG 2.
2	When testing a compressor on most water coolers, the amperage range should be between 1.0 Amp and 2.0 Amps depending on model. See specification sheet for the unit you are testing for a more accurate amp range. The amp range should be within ± 0.1 amps of the normal range. Readings outside of this range indicates a failing compressor.		
3	Remove the probes/leads from the meter, then turn the meter on by turning the dial to the 2/20A amp setting (FIG 2.).		
4	With the compressor running, open the jaws with the release lever and put it around one of the two conductors through which the current is to be measured. NOTE: Clamping around two conductors will give you a zero reading as amp flow in opposite directions will cancel each other out (FIG 3.).	FIG 3.	FIG 4.
5	Release the lever closing the two halves of the core and line up the conductor between the alignment marks on the jaws. If the clamp meter doesn't have the alignment marks, center the conductor inside the loop formed by the jaws(FIG 4.).		
6	The displayed result is the AC current and should be between 1.0-2.0A.		

TIP: Check clamp meter's batteries before use, weak batteries can cause false readings.

Testing Hot Gas Solenoid

Issue: No ice/Broken coupler/
cold water dispenses at 37
degrees or ambient/ no blinking
lights

Cause: Hot Gas Solenoid

**Refrigerant line
supplying the Evaporator**

this line will be hot when
unit in harvesting mode.

if it is room temp during
harvest mode, the
solenoid is not open.

24VDC

should be preset when
unit is in Harvest Mode if
no voltage present, bad
PCB

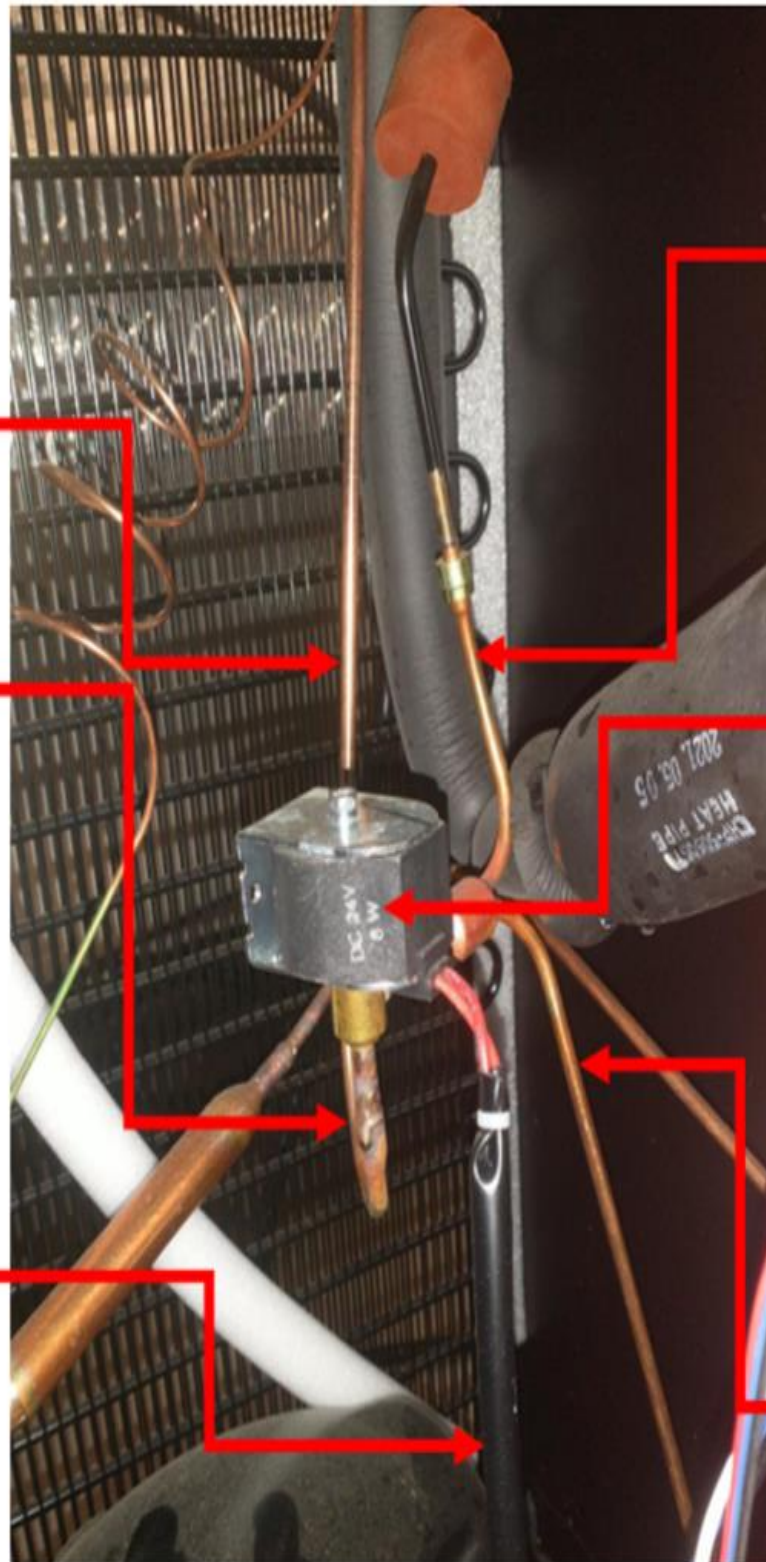

**Hot Gas
From Condensor**

Hot Gas Solenoid Coil.
Should read 88.5Ω If good,
if it reads opn or shorted out,
It is defective

**Cool Gas
From Compressor**